



Access
the
inaccessible®





Access the inaccessible®

From mountain summits to the depths of the earth, from rock faces to steep trails, from short-lived ice formations to rushing canyon waters, outdoor sports provide us with incomparable experiences, a unique connection with nature, and moments suspended in time. Petzl is by the side of all who are passionate about seeking out these extraordinary environments and contributes to their ability to access the inaccessible.

For 2021, our family of belay devices continues to grow, with the new YSI (*easy*) assisted braking belay device, designed for the gym and the crag. For your climbing needs, CORAX, SAMA, ADJAMA, SELENA and LUNA have evolved, with improved design and comfort. They are all available in kits that also include a belay device and Sm'D carabiner. The PICCHU helmet for children has been added to the line featuring the TOP AND SIDE PROTECTION label. And finally, for caving, the AVEN and SUPERAVANTI harnesses are now more durable and comfortable.

Happy reading, and have a great season!

The Petzl team

Contents

Petzl: a family's passion	page 2
Expertise and dedication to quality	4
New products for 2021	6
Verticality	28
Harnesses	30
Helmets	36
Belay devices and descenders	42
Ropes	48
Carabiners and quickdraws	56
Ice axes	62
Crampons	68
Ascenders	73
Pulleys	77
Lanyards	79
Kits	83
Anchors	85
Crashpads	90
Packs and accessories	92
Lighting	98
CLASSIC headlamps	112
ACTIVE headlamps	116
PERFORMANCE headlamps	120
SPECIALIZED headlamps	124
Spare parts	131
Product index	132
Petzl, also serving professionals	134
The Petzl Foundation	136

Access the inaccessible®

Petzl's mission is to create innovative tools and services that allow people to progress, position, and protect themselves in vertical environments, as well as to light their way in the dark. We continually look for the best solutions for user needs in terms of performance, ergonomics, comfort, and reliability. The demands and the commitment of users are what guide our approach to supporting them in their pursuit of the inaccessible. We have stood by their side for over 50 years.

Paul Petzl

Petzl: a name, its values

The Petzl brand on a product has always represented the commitment of the Petzl family to produce the best tools for its users.

The adventure began with Fernand Petzl's passion for caving, a passion to which he dedicated his talents as a craftsman. Petzl expertise began to grow with the design and crafting of solutions for ascending, descending, belaying and moving about in the dark. In 1970, the first "Fernand Petzl" brand products were produced in a workshop in Saint-Nazaire-Les Eymes, Isère, France. The Petzl company was created in 1975 and has grown into an international company that now employs over 800 people. Since its beginnings, it has preserved its family legacy and values: remaining independent and in control of its own decisions, developing a long-term vision, prioritizing people above all, and embracing its commitment to quality. Today, a family council, with Paul Petzl as president, ensures the continuity of the company.

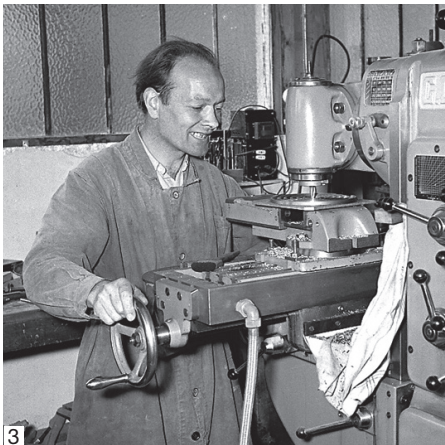
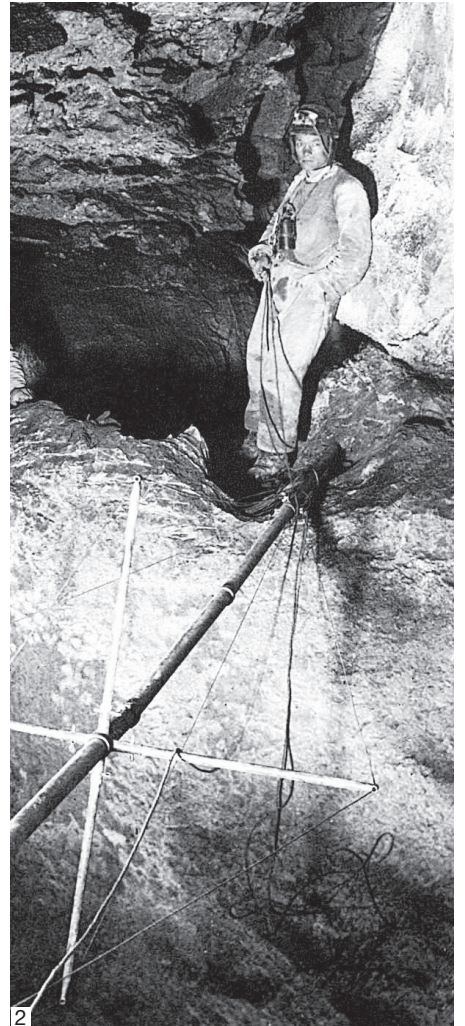

- (1) 2017: Paul Petzl and family
- (2) 1940: Fernand Petzl in the Dent de Crolles, France
- (3) 1970: Fernand Petzl in his workshop
- (4) The Petzl product signature

A pioneering business

To attain the inaccessible, you need to know how to reinvent yourself. Since the development of the first rope ascenders and descenders, which laid the foundation for rope progression, Petzl has been at the forefront of change and the emergence of new techniques. Headlamp lighting, belaying, rescue, ice climbing, glacier travel... In these and other fields, Petzl's innovations have allowed gear to evolve and practices to be reinvented. As proof of this dynamic activity, over 700 patents have been registered since 1970. These advances always result from a dialogue with the user, in order to understand his/her expectations and to provide the elements s/he needs. Petzl has always remained true to this method.

Petzl's philosophy for design and production is also based on accelerating change, transforming, and innovating in order to provide sports enthusiasts and professionals with the quality products they demand. Testing tower, experimentation center, individual inspections, LEAN manufacturing process - Petzl was a pioneer in all of these innovations.

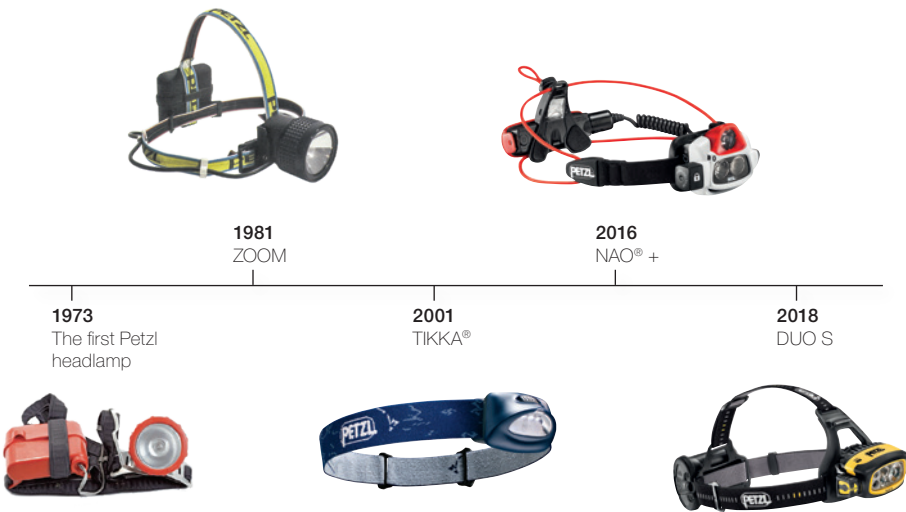

Headlamps: over forty years of innovation

1936: Fernand Petzl starts exploring the Dent de Crolles, France, and invents the tools he requires

1968: Our first rope ascenders and descenders (BASIC, SIMPLE) under the name Produits Fernand Petzl (Fernand Petzl Products)

1973: First Petzl mountaineering headlamp is developed

1975: Founding of the Petzl company in Crolles, France

1983: First Petzl harnesses

1991: GRIGRI®, first assisted blocking belay device

1998: TIBLOC®, ultra-compact rope ascender

2001: TIKKA®, the first LED headlamp

2004: ASAP® mobile fall arrester

2005: Petzl professional helmets

2006: EXO® personal escape system for New York City firefighters

2012: NAO® headlamp with REACTIVE LIGHTING technology

2013: SIROCCO helmet and ZIGZAG® mechanical Prusik for tree care

2015: SITTA harness for climbing and technical mountaineering

2017: GRIGRI® + belay device

2018: New DUO headlamps with FACE2FACE anti-glare technology

2019: Climbing and mountaineering helmets with TOP AND SIDE PROTECTION

2020: MAESTRO descenders for technical rescue

Education, communication

From the beginning, we have sought to provide technical answers to our users' needs. The answers come in the form of product design, but also in the sharing of our experience with verticality. This experience can be found in the technical notices for products, and in the technical advice in our catalogs and at Petzl.com.

The Petzl Solutions department is dedicated to education, through the sharing of our technical expertise. Petzl Solutions provides technical education modules and makes them available through a network of Petzl Technical Institutes around the world.

In order to share our values, we collaborate with top athletes in different disciplines. Mountaineers, climbers, trail runners, cavers... they are the ambassadors of our company and of the passion for the inaccessible. Many are involved with the fine-tuning of our products. See them at Petzl events, and through their stories on Petzl.com and on our social media platforms.



Expertise and dedication to quality

For over 40 years, Petzl has built on its expertise in the design and manufacture of products for verticality and lighting. Today, Petzl designs, produces and distributes millions of products around the world. Building a Petzl product requires expertise in a wide range of materials - textiles, metals, plastics - as well as in specific technologies: plastics processing, sewing, injection molding, forging, LEDs, electronics... This expertise allows us to design gear that meets both the needs of users and the technical requirements for its use: resistance to impacts, abrasion, extreme temperatures...

Design

The Petzl research department in Crolles, France, integrates all the fields related to product design: mechanical, textile, electronic, optical, computing and prototyping. Starting at the design and prototype phases, the reliability of the product and user safety are continually evaluated, with a strong focus on risks to the user.

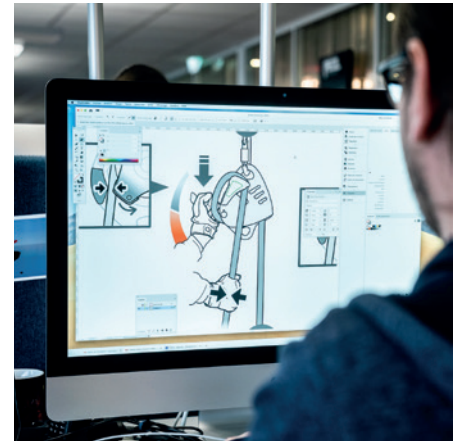
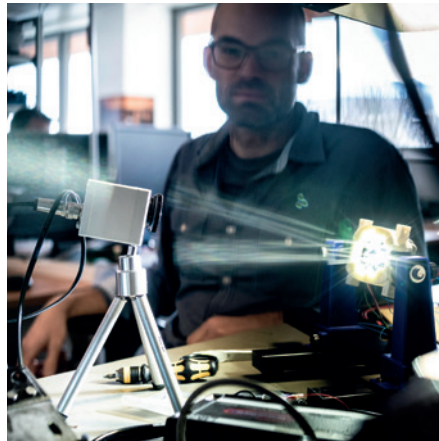

© Stef Candé

Testing

In Crolles, Petzl has labs dedicated to testing verticality products and headlamps. These tests often go above and beyond the required standards to help validate product reliability and user safety. Examples of tests: dynamic fall tests, impact resistance, cyclic testing, performance, headlamp beam quality and burn times. They are complemented by testing in the field for ergonomics and reliability.

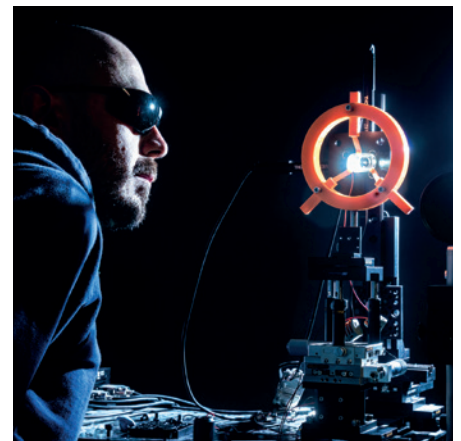

© Stef Candé

Production and inspection

Petzl's production sites are based in Crolles, Eybens, and Rotherens, France, and in Rawang, Malaysia. This production infrastructure is complemented by long-term partnerships with key suppliers in Europe and Asia. Our purchasing and quality control teams work closely with suppliers to guarantee a standard of product reliability and quality that meets our strict requirements. During the manufacturing phase, quality control is present at every step of the production chain. It combines automated and human inspections.

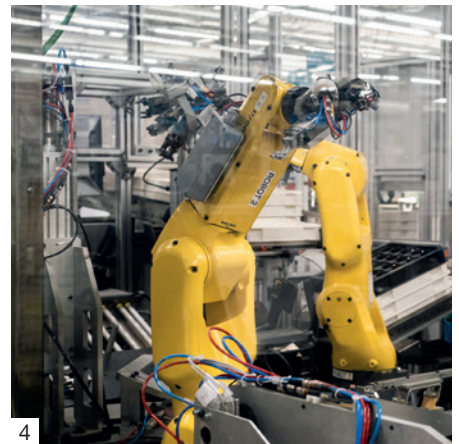

- (1) Head office and manufacturing in Crolles
- (2) Manufacturing in Rotherens, Eybens and Rawang
- (3) Sharpening ice axe picks
- (4) Automated production systems
- (5) Subsidiaries in Spain, Switzerland and USA

Distribution

Petzl distributes products to more than fifty countries via a distribution network, subsidiaries and agents around the world.

- Petzl subsidiaries and agents: Austria, Benelux, Denmark, Finland, France, Germany, Italy, Norway, Spain, Sweden, Switzerland, UK, USA
- Petzl distributors





Sasha DiGiulian belaying Édouard Biels on Si Voils Pots with an YSI, Chullita, Spain © 2020 - Petzl Distribution - Sam Blé



Harnesses



ADJAMA
pages 10, 33



LUNA
pages 10, 33



SAMA
pages 11, 33



SELENA
pages 11, 33



CORAX
pages 12, 34



AVEN
pages 13, 35



SUPERAVANTI
pages 13, 35



EXPLO
pages 14, 35



TORSE
pages 14, 35

Helmets



PICCHU
pages 15, 40



YSI (easy)
pages 15, 46



NANO TRAXION
pages 20, 78

Belay devices

Pulley

Ropes



VOLTA® GUIDE
9 mm
pages 16, 53



ARIAL® 9.5 mm
pages 17, 53



CONTACT®
9.8 mm
pages 18, 53



CONTACT® WALL
9.8 mm
pages 18, 53



MAMBO®
10.1 mm
pages 19, 53



PUR LINE 6 mm
pages 19, 55

Lanyards



CONNECT ADJUST
pages 21, 82



DUAL CONNECT
ADJUST
pages 21, 82



DUAL CONNECT
VARIO
pages 22, 82



DUAL CANYON CLUB
pages 23, 82



DUAL CANYON
GUIDE
pages 23, 82

Kits



KIT CORAX GRIGRI Sm'D
pages 24, 84



KIT CORAX YSI Sm'D
pages 24, 84



KIT VIA FERRATA EASHOOK
pages 25, 82, 84



KIT VIA FERRATA VERTIGO
pages 25, 82, 84

Anchors



GO 8 mm
pages 26, 88

Packs and accessories



BANDI
pages 26, 93



SAKA
pages 26, 93



TARP
pages 20, 55, 93



NEST
pages 27, 94

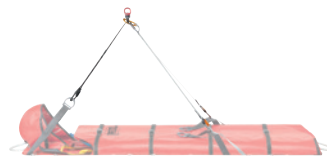

STEF
pages 27, 94



Bag for NEST litter
pages 27, 94

Headlamps

Discover the features of these new headlamps soon on PetzIdealer.com and in the IKO Workbook.



IKO
Lightweight headlamp with multi-beam and AIRFIT headband. 350 lumens



IKO CORE
Lightweight rechargeable headlamp with multi-beam and AIRFIT headband. 500 lumens



DUO RL
Ultra-powerful, waterproof and rechargeable headlamp, featuring Petzl's REACTIVE LIGHTING® technology

ADVANCED climbing and mountaineering harnesses

NEW
2021



ADJAMA

Climbing and mountaineering harness with adjustable leg loops, for single and multi-pitch climbing

Designed for technical mountaineering, trad climbing and multi-pitch climbing, the ADJAMA harness is equipped with adjustable leg loops that adapt to all climbers in all seasons. The padded leg loops and waistbelt ensure maximum comfort without hindering freedom of movement. The five gear loops carry all the gear required for progression on ice or rock, and make it easily accessible during the activity.

Selling points

- Comfortable to wear:
 - padded waistbelt and leg loops
 - wide waistbelt provides comfortable positioning
 - ENDOFRAME Technology construction allows optimal weight distribution
- Capacity for transporting a large quantity of gear:
 - two very large rigid gear loops in front for transporting a large amount of gear and for easy clipping and unclipping of carabiners
 - two rear gear loops are flexible, for bringing gear to the front and for comfort when carrying a backpack
 - one large center rear gear loop for carrying belay station gear, shoes or other special gear
 - compatible with the CARITool EVO tool holder
 - one rear loop for trail line
- Adaptability: leg loops adjustable with DOUBLEBACK buckles, to adapt to different body types and to seasonal clothing

Product specifications

- Material(s): nylon, polyester, EVA, polyurethane, aluminum, high-modulus polyethylene (HMPE)
- Certification(s): CE EN 12277 type C, UIAA

Accessory(ies)

CARITool EVO (P42 M)

Related product(s)

METEOR (A071AA00/1/2/3/4/5)
LASER SPEED (G051AA00/1/2)
QUARK (U019BA00, U019AA00)

Specifications by reference

See page 33

ADVANCED climbing and mountaineering harnesses

NEW
2021



LUNA

Women's climbing and mountaineering harness with adjustable leg loops for single and multi-pitch climbing

The LUNA harness is tailored to a woman's physique. Designed for technical mountaineering, trad climbing or multi-pitch climbing, the harness is equipped with adjustable leg loops to adapt to all climbers, in any season. The padded leg loops and waistbelt ensure maximum comfort without hindering freedom of movement. The five gear loops carry all the gear required for progression on ice or rock, and make it easily accessible during the activity.

Selling points

- Tailored to a woman's physique:
 - waistbelt is contoured to conform to the lower back
 - longer rise ensures better placement on the waist
 - leg loop-to-waistbelt proportions suited to women's physique
 - leg loops adjust with DOUBLEBACK buckles, to adapt to different body types and seasonal clothing
- Comfortable to wear:
 - padded waistbelt and leg loops
 - wide waistbelt provides comfortable positioning
 - ENDOFRAME Technology construction allows optimal weight distribution

- Capacity for transporting a large quantity of gear:
 - two very large rigid gear loops in front for transporting a large amount of gear and for easy clipping and unclipping of carabiners
 - two rear gear loops are flexible, for bringing gear to the front and for comfort when carrying a backpack
 - one large center rear gear loop for carrying belay station gear, shoes or other special gear
 - compatible with the CARITool EVO tool holder
 - one rear loop for trail line

Product specifications

- Material(s): nylon, polyester, EVA, polyurethane, aluminum, high-modulus polyethylene (HMPE)
- Certification(s): CE EN 12277 type C, UIAA

Accessory(ies)

CARITool EVO (P42 M)

Related product(s)

METEOR (A071AA00/1/2/3/4/5)
LASER SPEED (G051AA00/1/2)
QUARK (U019BA00, U019AA00)

Specifications by reference

See page 33

ADVANCED climbing and mountaineering harnesses

NEW
2021



SAMA

Climbing harness for the gym, crag, multi-pitch routes

Designed for sport climbing, the SAMA harness is comfortable for both gym and outdoor climbing. The elasticized leg loops remain adjusted and the waistbelt is flexible and slimmer in front to give great freedom of movement. The four gear loops provide sufficient space for the required gear.

Selling points

- Comfortable to wear:
 - padded waistbelt and leg loops
 - wide waistbelt provides comfortable positioning
 - ENDOFRAME Technology construction allows optimal weight distribution
- Great freedom of movement:
 - waistbelt is flexible and slimmer in front
 - elasticized leg loops allow the harness to remain adjusted
 - elasticized leg loop straps and flexible connection straps allow maximum mobility
- Capacity for carrying gear:
 - two rigid gear loops in front for easy clipping and unclipping of quickdraws
 - two rear gear loops are flexible, for bringing gear to the front and for comfort when carrying a backpack
 - one rear loop for trail line

Product specifications

- Material(s): nylon, polyester, EVA, polyurethane, aluminum, high-modulus polyethylene (HMPE)
- Certification(s): CE EN 12277 type C, UIAA

Related product(s)

GRIGRI® + (D13A G/AG/VI)
SAKA (S039BA00/1)
POWER BALL (P22AB 040)

Specifications by reference

See page 33

ADVANCED climbing and mountaineering harnesses

NEW
2021



SELENA

Women's harness for gym, crag or multi-pitch routes

The SELENA harness is tailored to a woman's physique. Designed for sport climbing, the harness is comfortable for both gym and outdoor climbing. The elasticized leg loops remain adjusted and the waistbelt is flexible and slimmer in front to give great freedom of movement. The four gear loops provide sufficient space for the required gear.

Selling points

- Tailored to a woman's physique:
 - waistbelt is contoured to conform to the lower back
 - longer rise ensures better placement on the waist
 - leg loop-to-waistbelt proportions suited to women's physique
- Comfortable to wear:
 - padded waistbelt and leg loops
 - wide waistbelt provides comfortable positioning
 - ENDOFRAME Technology construction allows optimal weight distribution
- Great freedom of movement:
 - waistbelt is flexible and slimmer in front
 - elasticized leg loops allow the harness to remain adjusted
 - elasticized leg loop straps and flexible connection straps allow maximum mobility

- Capacity for carrying gear:
 - two rigid gear loops in front for easy clipping and unclipping of quickdraws
 - two rear gear loops are flexible, for bringing gear to the front and for comfort when carrying a backpack
 - one rear loop for trail line

Product specifications

- Material(s): nylon, polyester, EVA, polyurethane, aluminum, high-modulus polyethylene (HMPE)
- Certification(s): CE EN 12277 type C, UIAA

Related product(s)

GRIGRI® + (D13A G/AG/VI)
SAKA (S039BA00/1)
POWER BALL (P22AB 040)

Specifications by reference

See page 33

DISCOVER climbing and mountaineering harnesses

NEW
2021



CORAX

Versatile and fully adjustable climbing and mountaineering harness

The CORAX is the versatile harness par excellence: easy to use and comfortable, it is designed for rock climbing, mountaineering or via ferrata. The four gear loops provide sufficient space for the required gear. This fully adjustable harness is available in three colors and in two sizes, to fit all preferences and body types.

Selling points

- Versatile and easy to use:
 - waistbelt equipped with two DOUBLEBACK buckles for easy centering and adjustment of harness. Gear loops are thus kept in an optimal position
 - adjustable leg loops allow easy adjustment of the harness to different body types and clothing
- Capable of transporting and organizing gear:
 - two rigid gear loops in front for easy clipping and unclipping of quickdraws
 - two rear gear loops are flexible, for bringing gear to the front and for comfort when carrying a backpack
 - one rear loop for trail line
 - compatible with the CARITool EVO tool holder for transporting ice screws
- Comfortable to wear:
 - FRAME Technology construction allows weight to be distributed between the waistbelt and the leg loops
 - pressure points lined with soft fabric
 - available in three colors and two sizes

Product specifications

- Material(s): high-strength polyester webbing, polyester, closed-cell foam
- Certification(s): CE EN 12277 type C, UIAA

Related product(s)

BOREO® (A042EA00/1, A042FA00/1, A042GA00/1, A042HA00/1)
BOREA (A048AA00, A048BA00, A048CA00)
Sm'D (M39A SL/RL)
CONNECT ADJUST (L034AA00)

Specifications by reference

See page 34

Caving harness

**NEW
2021**



AVEN

Comfortable, durable caving harness

AVEN is a comfortable, durable harness designed for caving. The foam-backed waistbelt and the wider leg loop straps ensure comfort for long vertical ascents and descents in caving. The TPU-reinforced leg loops and the HMPE gear loops and attachment points make this harness extremely durable. The attachment points are positioned as low as possible in order to make rope ascents easier and more efficient. It is equipped with six gear loops, two slots for a CARITOOl tool holder, and a bag tether attachment loop for transport and organization of gear.

Selling points

- Designed for comfort:
 - wide foam on waistbelt provides great comfort and support, without hampering general mobility or rope ascents
 - closed-cell foam waistbelt prevents water absorption and keeps the harness comfortable throughout its lifetime
 - wide leg loop straps offer better weight distribution between the thighs and the pelvis
 - leg loop buckles are positioned between the legs to limit the risk of snagging in narrow passages
- Reinforced for durability:
 - leg loops reinforced with thermoplastic polyurethane (TPU) for greater resistance to abrasion
 - waistbelt backing in polyester
 - gear loops in extremely durable high-modulus polyethylene (HMPE)

- high-strength polyester webbing retains smooth adjustment qualities over time
- attachment points entirely reinforced in high-modulus polyethylene (HMPE), for great durability
- rear buckle with wear protector webbing flap
- Efficient rope ascents:
 - rope ascent efficiency is optimized, thanks to the lower position of the attachment points
 - three gear loops on each side, for transport and organization of a large amount of gear
 - two slots for CARITOOl tool holder
 - differently colored safety stitching, for easy identification of harness size (yellow stitching for Size 1, black stitching for Size 2)
 - loop in high-modulus polyethylene (HMPE) for tethering a bag

Product specifications

- Material(s): high-modulus polyethylene (HMPE), thermoplastic polyurethane (TPU), steel, closed-cell foam
- Certification(s): CE

Accessory(ies)

EXPLO (C027AA00)

Related product(s)

OMNI (M37 SL/TL)
SIMPLE (D004AA00)
FREINO Z (M042AA00)
BASIC (B18BAA)
BOREO® CAVING (A042SA00/1)

Specifications by reference

See page 35

Caving harness

**NEW
2021**



SUPERAVANTI

Durable, lightweight caving harness

SUPERAVANTI is a durable, lightweight caving harness designed for a wide range of users. The TPU-reinforced leg loops and the HMPE gear loops and attachment points make this harness extremely durable. The attachment points are positioned as low as possible in order to make rope ascents easier and more efficient. It is equipped with four gear loops for the transport and organization of gear. The buckles are positioned inside the leg loops, limiting the risk of snagging in narrow passages. It is available in two sizes and offers a wide range of adjustments, to adapt to all body types.

Selling points

- Reinforced for durability:
 - leg loops reinforced with thermoplastic polyurethane (TPU) for greater resistance to abrasion
 - gear loops in extremely durable high-modulus polyethylene (HMPE)
 - high-strength polyester webbing retains smooth adjustment qualities over time
 - attachment points entirely reinforced in high-modulus polyethylene (HMPE), for great durability
 - rear buckle with wear protector webbing flap

- Efficient rope ascents:
 - rope ascent efficiency is optimized, thanks to the lower position of the attachment points
 - two gear loops on each side, for transport and organization of gear
- Adapts to any body type:
 - comes in two sizes, allowing you to switch from a children's size to an adult size
 - extensive waistbelt and leg loop adjustment options to fit a wide range of users
 - differently colored safety stitching, for quick identification of harness size (yellow stitching for Size 1, black stitching for Size 2)

Product specifications

- Material(s): high-modulus polyethylene (HMPE), thermoplastic polyurethane (TPU), steel
- Certification(s): CE

Accessory(ies)

TORSE (C026AA00)

Related product(s)

OMNI (M37 SL/TL)
STOP (D009AA00)
FREINO Z (M042AA00)
CROLL® S (B16BAA)
BOREO® CAVING (A042SA00/1)
CLUB 10 mm (R39AO 040/060/070, R39AW 040)

Specifications by reference

See page 35

Caving harness

**NEW
2021**



EXPLO

Shoulder straps for positioning a CROLL, with gear loops

The EXPLO shoulder straps allow the CROLL ventral ascender to remain correctly positioned in order to optimize efficiency and comfort during rope ascents. Each strap is equipped with two HMPE gear loops and two slots for carrying gear. The X-shaped construction ensures good positioning on the shoulders, and the chest strap allows precise adjustment of the tension on the ventral ascender.

Selling points

- Efficient and easy to use during rope ascents:
 - allows efficient positioning of the CROLL ventral ascender for rope ascents
 - two high-modulus polyethylene (HMPE) gear loops and two slots on each shoulder strap for carrying gear (PULSE temporary anchor, hangers, wrenches...)
- Quick adjustment:
 - X-shaped construction, easily adjusted without connection to harness
 - precise, instant adjustment of the tension on the CROLL ventral ascender, thanks to the quick-adjustment buckle on the chest strap
- Durability:
 - abrasion-resistant webbing for excellent durability
 - chest strap in high-modulus polyethylene (HMPE) is extremely durable over time
 - rear cross-over in thermoplastic polyurethane (TPU) for greater resistance to abrasion

Product specifications

- Material(s): high-modulus polyethylene (HMPE), thermoplastic polyurethane (TPU), polyester, steel

Related product(s)

AVEN (C013AA00/1)
CROLL® S (B16BAA)

Specifications by reference

See page 35

Caving harness

**NEW
2021**



TORSE

Shoulder straps for positioning a CROLL

The TORSE shoulder straps allow a CROLL ventral ascender to remain correctly positioned in order to optimize efficiency and comfort during rope ascents when caving. The buckles adjust quickly to ensure positioning on the harness. The simple and rugged construction makes the straps extremely durable.

Selling points

- Efficient and easy to use during rope ascents:
 - simple construction
 - allows efficient positioning of a CROLL ventral ascender for rope ascents
- Quick adjustment:
 - DOUBLEBACK buckle for quick, precise adjustment
 - rapid buckle facilitates placement and removal of the straps on the harness
- Durability:
 - abrasion-resistant webbing for excellent durability
 - aluminum DOUBLEBACK buckle

Product specifications

- Material(s): aluminum DOUBLEBACK adjustment buckle, plastic rear buckle, polyester webbing

Related product(s)

SUPERAVANTI (C012AA00/1)
CROLL® S (B16BAA)
CROLL® L (B016AA00)
CLUB 10 mm (R39AO 040/060/070, R39AW 040)

Specifications by reference

See page 35

Children's climbing and cycling helmet

NEW
2021



PICCHU

Children's climbing and cycling helmet with enhanced protection

Designed for children, the PICCHU helmet is adapted for climbing and cycling (European and American standards). It features a hard outer shell, to resist impact and scratches. Head-covering design provides enhanced protection against lateral, frontal and rear impact. Ventilated and made to fit a child's head, making it comfortable to wear.

Selling points

- Helmet meets multiple climbing and cycling standards:
 - climbing (CE EN 12492, UIAA)
 - European cycling (CE EN 1078)
 - United States cycling (CPSC safety standard - cycling helmets for children 5 and older)
- designed in accordance with Petzl's TOP AND SIDE PROTECTION label
- head-covering design for enhanced protection against lateral, frontal and rear impact
- Durable construction, made for children:
 - hard ABS outer shell is impact and scratch-resistant, for optimal durability
 - specifically sized for children between the ages of 3 and 8 (48-54 cm headband)
 - page of stickers allows the helmet to be personalized
- Comfort:
 - side openings for ventilation
 - headband and chinstrap are adjustable
 - narrow polyester webbing straps offer improved comfort

- headlamp can be attached using the four optimally placed clips
- comfort foam is removable and washable

Product specifications

- Material(s): ABS shell, expanded polystyrene (EPS) liner, polyester webbing
- Certification(s): CE EN 12492, UIAA, CE EN 1078, CPSC safety standard
- one-size-fits-all

Accessory(ies)

Absorbent replacement foam

Related product(s)

MACCHU® (C015AA00/1)
BODY (C018BA00)
QUISTITI (C068AA00)

Specifications by reference

See page 40

Assisted braking belay device

NEW
2021



YSI (easy)

Assisted braking belay device

Designed for all users, YSI (*easy*) is an assisted braking belay device for climbing both in the gym and at the crag. It provides particularly smooth rope glide, allowing users to give slack very quickly without needing to touch or unlock the device. Its braking is effective irrespective of carabiner cross-section and it can be used with all 8.5 to 11 mm single ropes.

Selling points

- Assisted braking belay device for the gym and crag:
 - giving slack and catching falls are accomplished using standard belay techniques, always keeping a hand on the brake side of the rope
 - easier belaying, thanks to assisted braking: when the climber falls, the rope tightens, engaging the moving brake plate and causing it to press the rope against the fixed brake plate. This creates a braking action that helps stop the rope from sliding through the device. Holding the brake side of the rope helps engage the moving brake plate; therefore, it is important to always hold the brake side of the rope
 - installation diagram engraved on the belay device
- Great versatility:
 - rope glides smoothly through the device, which makes giving slack faster and easier
 - simple operation that does not require the user to touch the device to give slack after the climber falls or rests
 - good ergonomics allow effective descent control

- Effective braking, regardless of carabiner cross-section:
 - compatible with most carabiners, thanks to the brake plate that brakes the rope, not the carabiner
 - optimal performance with D-shaped carabiners (Sm'D)
 - compatible with all 8.5 to 11 mm dynamic single ropes and optimized for those 9.5 to 10.5 mm

Product specifications

- Weight: 125 g
- Rope compatibility: single ropes between 8.5 and 11 mm
- Material(s): aluminum frame, stainless steel friction plate
- Certification(s): EN 15151-2, UIAA

Related product(s)

MACCHU® (C015AA00/1)
CORAX (C051AA00/1, C051BA00/1, C051CA00/1)
CONTACT® WALL 9.8 mm (R33AC 030/040)
ARIAL® 9.5 mm (R34AC 060/070/080, R34AD 060/070/080)

Specifications by reference

See page 46



Dynamic single ropes

**NEW
2021**



VOLTA® GUIDE 9 mm

Ultra-lightweight multipurpose 9 mm rope with UIAA Guide Dry treatment, for ultimate climbing and mountaineering performance

The VOLTA GUIDE 9 mm rope offers the extremely low weight and bulk needed for ultimate rock climbing performance, as well as the flexibility and complete water repellent treatment for mountaineering. The UIAA Guide Dry treatment gives it excellent water resistance and makes it well-suited to everyday use in extreme conditions. Its grip and handling make for easier manipulation. It is available in several lengths, depending on user needs, from 30 meters for classic mountaineering to 100 meters for longer routes and rock climbing.

Selling points

- Compact and ultra-lightweight for ultimate climbing performance:
 - ultra-lightweight; only 54 g/m
 - compact, thanks to its thin 9 mm diameter
 - ClimbReady Coil: specific coil makes the rope ready to use. It helps the user avoid initial uncoiling mistakes, and increases longevity
- Perfect for technical mountaineering and ice climbing, thanks to its excellent water resistance:
 - UIAA Guide Dry treatment: water repellent treatment allows users to keep their rope dry, day after day, no matter what the conditions. It meets the requirements of the UIAA standard water repellent test: water absorption of less than 2 %
 - UIAA Guide Dry treatment extends the life of the rope
 - UltraSonic Finish: the core and sheath are bonded together at the rope ends by an ultrasonic process. It provides greater durability and prevents frayed ends
- Comfort:
 - flexible rope makes it easier to uncoil, handle loops and give slack with belay devices
 - 40-carrier grip for better control
 - EverFlex treatment: specific thermal treatment stabilizes core strands and improves consistency Provides excellent grip and handling over time

Product specifications

- Diameter: 9 mm
- Type of rope: (CE EN 892, UIAA): multi-type - single, half, and twin
- Weight per meter: 54 g
- Percentage of sheath: 39 %
- Number of factor 1.77 falls: 5 (single), > 20 (half), > 25 (twin)
- Static stretch: 7.6 % (single), 7.6 % (half), 4.4 % (twin)
- Dynamic elongation: 34 % (single), 30 % (half), 27 % (twin)
- Fall impact: 8.5 kN (single), 6.6 kN (half), 10.4 kN (twin)
- Construction: 40 carrier
- Material(s): nylon

Related product(s)

SITTA (C10AO S/M/L)
SIROCCO® (A073AA00/1, A073BA00/1)
GRIGRI® (D014BA00/1/2)
SPIRIT EXPRESS (M053AA00/1)

Specifications by reference

See page 53

Dynamic single ropes

**NEW
2021**



ARIAL® 9.5 mm

Lightweight and durable 9.5 mm single rope with Duratec Dry treatment for climbing and alpinism

Lightweight and durable, the ARIAL 9.5 mm is a single rope designed for climbing and alpinism. Its Duratec Dry treatment provides maximum longevity and performance under many conditions. Protected by a thicker sheath, it is an ideal rope for climbers repeatedly trying the moves on their project. Its excellent grip and great handling make for easier manipulation.

Selling points

- durable rope suited to working a route:
 - thick sheath provides excellent abrasion resistance
 - great diameter-to-durability ratio
 - Duratec Dry treatment extends the life of the rope
 - UltraSonic Finish: the core and sheath are bonded together at the rope ends by an ultrasonic process. It provides greater durability and prevents frayed ends
- Comfort:
 - flexible rope makes it easier to give slack with belay devices
 - EverFlex treatment: specific thermal treatment stabilizes core strands and improves consistency. It provides excellent grip and consistent handling over time
 - Duratec Dry treatment for use in rock, mixed, snow or ice environments: water repellent treatment makes the rope more resistant to water, dirt and abrasion. Handling, grip and other characteristics are retained longer in cold, wet conditions
 - ClimbReady Coil: specific coil makes the rope ready to use. It helps the user avoid initial uncoiling mistakes, and increases longevity
- Grip makes for easier handling:
 - 40-carrier grip for better control
 - Middle Mark: indicates the middle of the rope to facilitate maneuvers

Product specifications

- Diameter: 9.5 mm
- Type of rope: (CE EN 892, UIAA): single rope
- Weight per meter: 58 g
- Percentage of sheath: 40 %
- Number of factor 1.77 falls: 7
- Static elongation: 7.6 %
- Dynamic elongation: 32 %
- Impact force: 8.8 kN
- Construction: 40 carrier
- Material(s): nylon

Related product(s)

METEOR (A071AA00/1/2/3/4/5)
 KLIFF (S010AA00/1)
 ADJAMA (C022BA00/1/2/3)
 LUNA (C035BA00/1/2/3)
 GRIGRI® (D014BA00/1/2)
 CONNECT ADJUST (L034AA00)

Specifications by reference

See page 53

Dynamic single ropes

**NEW
2021**



CONTACT® 9.8 mm

9.8 mm diameter lightweight single rope for gym or rock climbing

The CONTACT 9.8 mm single rope is designed for gym and rock climbing. It strikes an excellent balance between low weight and durability for greater versatility. Its excellent grip and great handling make for easier manipulation and use of belay devices. The thickness of its sheath also contributes to its durability.

Selling points

- **Comfort:**
 - flexible rope makes it easier to give slack with belay devices
 - EverFlex treatment: specific thermal treatment stabilizes core strands and improves consistency. It provides excellent grip and consistent handling over time
 - ClimbReady Coil: specific coil makes the rope ready to use. It helps the user avoid initial uncoiling mistakes, and increases longevity
- **Grip makes for easier handling:**
 - excellent balance of weight, diameter, and grip
 - 40-carrier grip for better control
 - Middle Mark: indicates the middle of the rope, to facilitate maneuvers
- **Durability:**
 - thick sheath provides excellent abrasion resistance
 - UltraSonic Finish: the core and sheath are bonded together at the rope ends by an ultrasonic process. It provides greater durability and prevents frayed ends

Product specifications

- Diameter: 9.8 mm
- Type of rope: (CE EN 892, UIAA): single rope
- Weight per meter: 60 g
- Percentage of sheath: 41 %
- Number of factor 1.77 falls: 7
- Static elongation: 9.0 %
- Dynamic elongation: 35 %
- Impact force: 8.4 kN
- Construction: 40 carrier
- Material(s): nylon

Related product(s)

CONNECT ADJUST (L034AA00)
SAMA (C021BA00/1/2/3)
SELENA (C055BA00/1/2/3)
DJINN AXESS (M060CA00/1/2)
BOREO® (A042EA00/1, A042FA00/1, A042GA00/1, A042HA00/1)

Specifications by reference

See page 53

Dynamic single ropes

**NEW
2021**



CONTACT® WALL 9.8 mm

9.8 mm diameter lightweight single rope for gym climbing

The CONTACT WALL 9.8 mm single rope is dedicated to gym climbing. Lengths adapted to gym use, 30 and 40 meters, preserve users' rock climbing ropes while limiting both the weight and bulk of their gym climbing bags. Strikes an excellent balance between low weight and durability for greater versatility. Excellent grip and great handling make for easier manipulation and use of belay devices. The thickness of the sheath also contributes to its durability.

Selling points

- **Comfort:**
 - specific lengths suited to gym climbing allow users to preserve their rock climbing ropes
 - flexible rope makes it easier to give slack with belay devices
 - EverFlex treatment: specific thermal treatment stabilizes core strands and improves consistency. It provides excellent grip and consistent handling over time
 - ClimbReady Coil: specific coil makes the rope ready to use. It helps the user avoid initial uncoiling mistakes, and increases longevity
- **Grip makes for easier handling:**
 - excellent balance of weight, diameter, and grip
 - 40-carrier grip for better control
 - Middle Mark: indicates the middle of the rope to facilitate maneuvers

- **Durability:**
 - thick sheath provides excellent abrasion resistance
 - UltraSonic Finish: the core and sheath are bonded together at the rope ends by an ultrasonic process. It provides greater durability and prevents frayed ends

Product specifications

- Diameter: 9.8 mm
- Type of rope: (CE EN 892, UIAA): single rope
- Weight per meter: 60 g
- Percentage of sheath: 41 %
- Number of factor 1.77 falls: 7
- Static elongation: 9 %
- Dynamic elongation: 35 %
- Impact force: 8.4 kN
- Construction: 40 carrier
- Material(s): nylon

Related product(s)

Sm'D (M39A SL/RL)
KAB (S011AA00)
GRIGRI® + (D13A G/AG/VI)
CORAX (C051AA00/1, C051BA00/1, C051CA00/1)

Specifications by reference

See page 53

Dynamic single ropes

**NEW
2021**



MAMBO® 10.1 mm

10.1 mm diameter single rope with good grip for gym or rock climbing

With its generous diameter, the MAMBO 10.1 mm single rope is a reassuring option for gym and rock climbing. Its 10.1 mm diameter provides excellent grip, allowing users to familiarize themselves with the handling and use of belay devices. The thickness of its sheath also contributes to its durability.

Selling points

- Grip makes for easier handling:
 - generous diameter allows better control in belay devices
 - 40-carrier grip for better control
 - Middle Mark: indicates the middle of the rope, to facilitate maneuvers
- Comfort:
 - flexible rope makes it easier to give slack with belay devices
 - EverFlex treatment: specific thermal treatment stabilizes core strands and improves consistency. It provides excellent grip and consistent handling over time
 - ClimbReady Coil: specific coil makes the rope ready to use. It helps the user avoid initial uncoiling mistakes, and increases longevity
- Durability:
 - large diameter allows great durability
 - thick sheath provides excellent abrasion resistance
 - UltraSonic Finish: the core and sheath are bonded together at the rope ends by an ultrasonic process. It provides greater durability and prevents frayed ends

Product specifications

- Diameter: 10.1 mm
- Type of rope: (CE EN 892, UIAA): single rope
- Weight per meter: 65 g
- Percentage of sheath: 37 %
- Number of factor 1.77 falls: 7
- Static elongation: 8.5 %
- Dynamic elongation: 34 %
- Impact force: 8.5 kN
- Construction: 40 carrier
- Material(s): nylon

Related product(s)

GRIGRI® (D014BA00/1/2)
CORAX (C051AA00/1, C051BA00/1, C051CA00/1)
KLIFF (S010AA00/1)
CONNECT ADJUST (L034AA00)
BOREO® (A042EA00/1, A042FA00/1, A042GA00/1, A042HA00/1)

Specifications by reference

See page 53

Technical cords

**NEW
2021**



PUR LINE 6 mm

Ultra-lightweight and ultra-durable hyperstatic cord designed for climbers and alpinists, for hauling packs and retrieving single ropes during rappels

Designed for climbers and alpinists, the PUR LINE 6 mm is an ultra-lightweight and ultra-durable cord for hauling a pack or retrieving a single rope during a rappel. It is hyperstatic and features a rough-textured sheath, for good grip and easy handling. It is available in two lengths: 65-meter coils and 200-meter rolls.

Selling points

- Ultra-light and compact: only 20 grams per meter
- Easier grip and handling:
 - rigid cord makes both stowage at anchor and rope throwing during rappels easier
 - rough-textured sheath provides a good grip for hauling packs and retrieving a single rope during rappels
- Extremely durable:
 - 100 % HMPE construction that is extremely abrasion-resistant
 - compatible with most Petzl ascenders and progress-capture pulleys, thanks to its specific reinforced sheath
- Product comes in 200-meter rolls that can be cut to the desired length, or in 65-meter length to compensate for the elasticity of a 60-meter dynamic rope during rappels

Product specifications

- Diameter: 6 mm
- Weight per meter: 20 g
- Material(s): high-density polyethylene (HMPE)
- Certification(s): CE EN 564
- Static elongation: less than 2 %

Related product(s)

TIBLOC (B01B)
NANO TRAXION (P053AA00)
MICRO TRAXION (P53)
REVERSO® (D017AA00/1/2)
SIROCCO® (A073AA00/1, A073BA00/1)
VOLTA® 9.2 mm (R35AN 050/060/070/080)
R35AO 030/050/060/070/080/100)
VOLTA® GUIDE 9 mm (R36AO 030/40/50/60, R36AO 080/100)

Specifications by reference

See page 55

Climbing packs

**NEW
2021**



TARP

Large rope tarp

TARP is a large rope tarp. It provides a 140 x 140 cm clean area to protect ropes from dust and dirt. It features four handles for easier transport and color-coding for quick rope end identification. Its coated canvas construction makes it highly durable.

Selling points

- Very large rope tarp:
 - provides a 140 x 140 cm clean area for ropes
 - protects rope from dust and dirt
 - also great for long ropes
 - quick stowing, without the need to coil the rope
- Easy to use:
 - four handles for easier transport
 - color-coded for easy rope end identification
 - orange borders provide quick visual identification
- Durable and versatile:
 - abrasion-resistant coated canvas
 - can be installed above to provide protection from the sun or rain

Product specifications

- Dimensions: 140 x 140 cm
- Weight: 280 g
- Material(s): polyester

Related product(s)

VOLTA® 9.2 mm (R35AN 050/060/070/080, R35AO 030/050/060/070/080/100)
 ARIAL® 9.5 mm (R34AC 060/070/080, R34AD 060/070/080)
 CONTACT® 9.8 mm (R33AC 060/070/080, R33AD 060/070/080)
 MAMBO® 10.1 mm (R32AC 050/060/070, R32AD 050/060/070)
 KLIFF (S010AA00/1)

Specifications by reference

See pages 55, 93

Progress-capture pulleys

**NEW
2021**



NANO TRAXION

High-efficiency, ultra-lightweight progress-capture pulley

NANO TRAXION is an ultra-lightweight (53 g) and compact progress-capture pulley designed for rescue. Sealed ball bearings provide excellent efficiency (91 %).

Selling points

- Ultra-light and compact:
 - only 53 g
 - very compact
 - hole allows a Sm'D carabiner to be connected to the pulley with a cord, making the device loss-proof
- Designed for rescue
- High efficiency:
 - sealed ball bearings provide excellent efficiency (91 %)
 - works even on frozen or muddy ropes
 - for use on 7 to 11 mm diameter ropes
 - rope installation diagrams engraved inside the pulley

Product specifications

- Weight: 53 g
- Certification(s): CE EN 567, UIAA
- Min. rope diameter: 7 mm
- Max. rope diameter: 11 mm
- Sheave type: sealed ball bearings
- Sheave diameter: 25 mm
- Breaking strength: 2 x 7.5 = 15 kN
- Breaking strength as progress-capture pulley: 4 kN
- Efficiency: 91 %

Related product(s)

Sm'D (M39A SL/RL)

Specifications by reference

See page 78

Climbing and mountaineering lanyards

NEW
2021

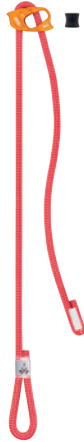

CONNECT ADJUST

Adjustable single lanyard for climbing and mountaineering

Designed for climbing and mountaineering, CONNECT ADJUST is a single positioning lanyard that allows users to tether themselves to an anchor. The adjustable arm allows the length to be adapted for easier handling. Because of its ergonomics, the ADJUST rope adjuster allows quick and easy one-handed adjustment.

Selling points

- Single positioning lanyard allows you to tether yourself to the station during climbing and mountaineering
- Adjustable single lanyard:
 - 15 to 95 cm adjustable arm
 - the ADJUST rope adjuster's ergonomics make it easy to manipulate, for quick and precise adjustment of the adjustable arm
 - dynamic rope lanyard, to reduce the force transmitted to the user in the event of a short fall (1)
- Easy to use:
 - the connector is held in position by a rubber ring, to facilitate clipping
 - one-handed adjustment
 - used with a SPIRIT SCREW-LOCK-type locking carabiner
 - attaches to the belay loop with a simple girth hitch

Product specifications

- Length: 15 - 95 cm
- Weight: 125 g
- Certification(s): CE, UIAA 109
- Material(s): nylon, aluminum, thermoplastic elastomer (TPE)

Related product(s)

Sm'D (M39A SL/RL)
CORAX (C051AA00/1, C051BA00/1, C051CA00/1)
BOREO® (A042EA00/1, A042FA00/1, A042GA00/1, A042HA00/1)
BOREA (A048AA00, A048BA00, A048CA00)
GRIGRI® (D014BA00/1/2)

Specifications by reference

See page 82

Climbing and mountaineering lanyards

NEW
2021



DUAL CONNECT ADJUST

Adjustable double lanyard for climbing and mountaineering

Designed for multi-pitch climbing and mountaineering, DUAL CONNECT ADJUST is an adjustable double lanyard that allows users to tether themselves to an anchor and install a rappel system. The adjustable arm allows the length to be adapted for easier handling. Because of its ergonomics, the ADJUST rope adjuster allows quick and easy one-handed adjustment.

Selling points

- Adjustable double lanyard allows users to tether themselves to an anchor and install a rappel system in multi-pitch climbing and mountaineering
- Double lanyard with one fixed arm and one adjustable arm:
 - 45 cm fixed arm
 - 15 to 95 cm adjustable arm
 - the ADJUST rope adjuster's ergonomics make it easy to manipulate, for quick and precise adjustment of the adjustable arm
 - dynamic rope lanyard, to reduce the force transmitted to the user in the event of a short fall (1)
- Easy to use:
 - the connector is held in position by a rubber ring, to facilitate clipping
 - one-handed adjustment
 - used with two SPIRIT SCREW-LOCK-type locking carabiners
 - attaches to the belay loop with a simple girth hitch

Product specifications

- Fixed arm length: 45 cm
- Adjustable arm length: 15 to 95 cm
- Weight: 160 g
- Certification(s): CE, UIAA 109
- Material(s): nylon, aluminum, thermoplastic elastomer (TPE)

Related product(s)

Sm'D (M39A SL/RL)
REVERSO® (D017AA00/1/2)
METEOR (A071AA00/1/2/3/4/5)
ADJAMA (C022BA00/1/2/3)
LUNA (C035BA00/1/2/3)

Specifications by reference

See page 82

(1) For use below the anchor point: positioning lanyards do not have an energy absorber. These lanyards must only be used when the potential fall factor is less than 1.

Climbing and mountaineering lanyards

NEW
2021



DUAL CONNECT VARIO

Completely adjustable double lanyard and anchor system for climbing and mountaineering

DUAL CONNECT VARIO is an adjustable double lanyard designed for multi-pitch climbing, mountaineering and canyoning. It is versatile and may be used for tethering oneself, or for installing a rappel system or an equalized belay station. The adjustable arm allows the length to be adapted to the requirements of a rappel or an equalized belay station. Because of its ergonomics, the ADJUST rope adjuster allows quick and easy one-handed adjustment.

Selling points

- Adapts to climbing, mountaineering and canyoning uses:
 - may be used as a double lanyard to tether oneself, to install a rappel system or to move along a traverse line
 - may be used to install an equalized belay station, which can be re-adjusted once installed
- Completely adjustable double lanyard:
 - allows optimal positioning at the anchor, to facilitate maneuvers
 - length of fixed arm can be adjusted to the climber's needs
 - the ADJUST rope adjuster's ergonomics make it easy to manipulate, for quick and precise adjustment of the adjustable arm
 - dynamic rope lanyard, to reduce the force transmitted to the user in the event of a short fall (1)
- Easy to use:
 - the connectors are held in position by a rubber ring and a plastic sheath, to facilitate clipping
 - one-handed adjustment
 - is used with two Sm'D-type locking carabiners (e.g., SCREW-LOCK on the fixed arm and TWIST-LOCK on the adjustable arm)

Product specifications

- Length: 180 cm
- Weight: 180 g
- Certification(s): CE, UIAA 109
- Material(s): nylon, aluminum, thermoplastic elastomer (TPE)

Related product(s)

Sm'D (M39A SL/RL)
CORAX (C051AA00/1, C051BA00/1, C051CA00/1)
BOREO® (A042EA00/1, A042FA00/1, A042GA00/1, A042HA00/1)
BOREA (A048AA00, A048BA00, A048CA00)
GRIGRI® (D014BA00/1/2)

Specifications by reference

See page 82

(1) For use below the anchor point: positioning lanyards do not have an energy absorber. These lanyards must only be used when the potential fall factor is less than 1.

Canyoning lanyards

**NEW
2021**



DUAL CANYON CLUB

Double lanyard for canyoning

Designed for canyoning, the DUAL CANYON CLUB is an easy-to-use lanyard designed for groups. It allows progression on a lifeline with intermediate anchors, and positioning at an anchor. It attaches easily to the CANYON CLUB harness with a simple girth hitch. The plastic sheaths hold the carabiners in position and protect the stitching from abrasion.

Selling points

- Easy-to-use lanyard designed for canyoning groups:
 - allows progression on a lifeline with intermediate anchors, and positioning at an anchor
 - attaches easily to the CANYON CLUB harness with a girth hitch
 - ends equipped with plastic sheath to help hold the carabiners in place and protect the stitching from abrasion
- Individual identification marking on plastic sheath, to track the gear throughout its lifespan
- Dynamic rope lanyard, to reduce the force transmitted to the user in the event of a short fall (1)

Product specifications

- Material(s): nylon rope, thermoplastic polyurethane (TPU) sheaths
- Length of arms: 65 cm
- Weight: 130 g
- Certification(s): CE, UIAA 109

Specifications by reference

See page 82

Canyoning lanyards

**NEW
2021**

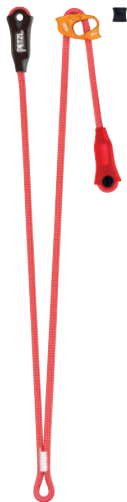

DUAL CANYON GUIDE

Adjustable double lanyard for canyoning

Designed for canyoning, the DUAL CANYON GUIDE is an easy-to-use lanyard designed for expert users and guides. It allows progression on a lifeline with intermediate anchors, and optimal positioning at an anchor. It attaches directly to the pin of the gated attachment point on the CANYON GUIDE harness. The ADJUST rope adjuster's ergonomic shape offers simple, quick adjustment. The plastic sheaths hold the carabiners in position and protect the stitching from abrasion.

Selling points

- Easy-to-use canyoning lanyard designed for expert users and guides:
 - attaches directly to the pin of the gated attachment point on the CANYON GUIDE harness, reducing bulk
 - adjustable arm is quick and easy to lengthen/shorten with a single hand, thanks to the ADJUST rope adjuster
 - connectors are kept in position for easier clipping, thanks to the TANGA ring and the plastic sheath on the fixed arm
- Versatile:
 - at the belay: adjustable arm allows length to be adjusted for optimal positioning
 - progressing on a lifeline: fixed arm and adjustable arm are same length to facilitate belay when passing intermediate anchors

- Durability:
 - plastic sheaths at the arm ends help protect stitching from abrasion
 - individual identification marking on plastic sheath, to track the gear throughout its lifespan
- Dynamic rope lanyard, to reduce the force transmitted to the user in the event of a short fall (1)

Product specifications

- Material(s): nylon rope, thermoplastic polyurethane (TPU) sheaths, aluminum ADJUST rope adjuster, thermoplastic elastomer (TPE) TANGA ring
- Fixed arm length: 65 cm
- Adjustable arm length: 15 to 80 cm
- Weight: 175 g
- Certification(s): CE, UIAA 109

Specifications by reference

See page 82

Climbing kits

NEW
2021



KIT CORAX GRIGRI Sm'D

Climbing kit containing CORAX harness, GRIGRI assisted blocking belay device, and Sm'D carabiner

For those who wish to improve their climbing skills, the KIT CORAX GRIGRI Sm'D includes a versatile and fully adjustable CORAX harness, a GRIGRI assisted blocking belay device, and an Sm'D carabiner with TRIACT-LOCK locking system.

Selling points

- Ideal kit for evolving climbers:
 - a CORAX harness (gray)
 - a GRIGRI assisted blocking belay device (gray)
 - an Sm'D carabiner with TRIACT-LOCK locking system
- Versatile and fully adjustable CORAX harness:
 - comfortable, durable construction
 - waistbelt and leg loops are adjustable, to adapt to summer and winter activities
- GRIGRI assisted blocking belay device:
 - easier belaying, thanks to cam-assisted blocking
 - exceptional convenience when lowering

Product specifications

- Certification(s):
 - CORAX harness: CE EN 12277 type C, UIAA
 - GRIGRI belay device: CE EN 15151-1, UIAA
 - Sm'D TRIACT-LOCK carabiner: CE EN 12275, UIAA

Related product(s)

BOREO® (A042EA00/1, A042FA00/1, A042GA00/1, A042HA00/1)
 BOREA (A048AA00, A048BA00, A048CA00)
 CONTACT® 9.8 mm (R33AC 060/070/080, R33AD 060/070/080)
 BANDI (S038BA00/1)
 POWER BALL (P22AB 040)

Specifications by reference

See page 84

Climbing kits

NEW
2021



KIT CORAX YSI Sm'D

Climbing kit containing CORAX harness, YSI assisted braking belay device, and Sm'D carabiner

For those who wish to improve their climbing skills, the KIT CORAX YSI Sm'D includes a versatile and fully adjustable CORAX harness, an YSI assisted braking belay device, and an Sm'D carabiner with SCREW-LOCK locking system.

Selling points

- Ideal kit for evolving climbers:
 - a CORAX harness (gray)
 - a YSI assisted braking belay device (gray)
 - an Sm'D carabiner with SCREW-LOCK locking system
- Versatile and fully adjustable CORAX harness:
 - comfortable, durable construction
 - waistbelt and leg loops are adjustable, to adapt to summer and winter activities
- YSI assisted braking belay device:
 - easier belaying, thanks to the assisted braking
 - very smooth, for giving slack quickly without touching the device

Product specifications

- Certification(s):
 - CORAX harness: CE EN 12277 type C, UIAA
 - YSI belay device: EN 15151-2, UIAA
 - Sm'D SCREW-LOCK carabiner: CE EN 12275, UIAA

Related product(s)

BOREO® (A042EA00/1, A042FA00/1, A042GA00/1, A042HA00/1)
 BOREA (A048AA00, A048BA00, A048CA00)
 CONTACT® 9.8 mm (R33AC 060/070/080, R33AD 060/070/080)
 BANDI (S038BA00/1)
 POWER BALL (P22AB 040)

Specifications by reference

See page 84

NOT AVAILABLE

Via ferrata kits

NEW
2021



KIT VIA FERRATA EASHOOK

Via ferrata kit includes a SCORPIO EASHOOK lanyard, a CORAX harness, and a BOREO helmet

The KIT VIA FERRATA EASHOOK contains a complete set of gear specific to via ferrata. The kit includes an ergonomic SCORPIO EASHOOK lanyard, a fully adjustable CORAX harness, and a BOREO helmet in size M/L.

Selling points

- Complete kit for via ferrata:
 - a SCORPIO EASHOOK lanyard for via ferrata
 - a CORAX harness (gray)
 - a BOREO helmet (white, size M/L)
- SCORPIO EASHOOK lanyard for via ferrata:
 - for users weighing 40 to 120 kg
 - comfortable, with SWIVEL anti-twist system and captive carabiners
 - rugged and durable
- Fully adjustable CORAX harness:
 - DOUBLEBACK buckles on waistbelt and leg loops allow the harness to be easily adjusted
 - comfortable, versatile and easy to use
- BOREO helmet:
 - durable and versatile
 - head-covering design for enhanced protection against lateral, frontal and rear impact
 - totally adjustable to head size

Product specifications

- Certification(s):
 - SCORPIO EASHOOK lanyard: CE EN 958: 2017
 - CORAX harness: CE EN 12277 type C, UIAA
 - BOREO helmet: CE EN 12492, UIAA

Specifications by reference

See page 84

Via ferrata kits

NEW
2021



KIT VIA FERRATA VERTIGO

Via ferrata kit includes a SCORPIO VERTIGO lanyard, a CORAX harness, and a BOREO helmet

The KIT VIA FERRATA VERTIGO contains a complete set of gear specific to via ferrata. The kit includes a SCORPIO VERTIGO lanyard, a fully adjustable CORAX harness, and a BOREO helmet in size M/L.

Selling points

- Complete kit for via ferrata:
 - a SCORPIO VERTIGO lanyard for via ferrata
 - a CORAX harness (gray)
 - a BOREO helmet (white, size M/L)
- SCORPIO VERTIGO lanyard for via ferrata:
 - for users weighing 40 to 120 kg
 - lightweight and comfortable with two elasticized arms and a short arm
 - rugged and durable
- Fully adjustable CORAX harness:
 - DOUBLEBACK buckles on waistbelt and leg loops allow the harness to be easily adjusted
 - comfortable, versatile and easy to use
- BOREO helmet:
 - durable and versatile
 - head-covering design for enhanced protection against lateral, frontal and rear impact
 - totally adjustable to head size

Product specifications

- Certification(s):
 - SCORPIO VERTIGO lanyard: CE EN 958: 2017
 - CORAX harness: CE EN 12277 type C, UIAA
 - BOREO helmet: CE EN 12492, UIAA

Specifications by reference

See page 84

Quick links

**NEW
2021**



GO 8 mm

8 mm wide-opening, galvanized steel quick link

GO 8 mm is an 8 mm wide-opening quick link, which may be used for permanent connection of sling webbing to an anchor. It may also be left at an anchor for rappel installation. The galvanized steel frame ensures excellent resistance.

Selling points

- May be used for permanent connection of sling webbing to an anchor, or left at an anchor for rappel installation
- Closes with a wrench, to avoid accidental opening
- Durability:
 - 8 mm diameter favors durability
 - galvanized steel frame is extremely resistant
- Sold in packs of 10, or individually

Product specifications

- Weight: 95 g
- Major axis MBS: 30 kN
- Gate opening: 17 mm
- Material(s): galvanized steel
- Certification(s): CE EN 12275, EN 362

Specifications by reference

See page 88

Chalk bags

**NEW
2021**



BANDI

Chalk bag with round shape

The BANDI chalk bag has a round shape with a large opening to accommodate the entire hand. The soft fabric won't cause discomfort when wearing a pack or when your back is against a rock wall. Practical closure system with drawstring and cordlock. It can be opened with only one hand should you forget to open it before you start climbing.

Selling points

- Round shape accommodates the entire hand
- Rigid rim maintains the shape of the bag
- Closure system in woven fabric prevents chalk from spilling out during transport
- Textile toothbrush holder for better hold of all types of brushes
- Liner sewn into bottom of bag to avoid flipping it when pulling hand out of the chalk bag

Product specifications

- Material(s): nylon, polyester
- Weight: 75 g

Related product(s)

CORAX (C051AA00/1, C051BA00/1, C051CA00/1)

Specifications by reference

See page 93

Chalk bags

**NEW
2021**



SAKA

Chalk bag with ergonomic shape

The SAKA chalk bag's ergonomic shape allows easy access to the chalk. The soft fabric won't cause discomfort when wearing a pack or when your back is against a rock wall. Practical closure system with drawstring and cordlock. It can be opened with only one hand should you forget to open it before you start climbing.

Selling points

- Ergonomic shape for easy hand access
- Rigid rim maintains the shape of the bag
- Closure system in woven fabric prevents chalk from spilling out during transport
- Textile toothbrush holder for better hold of all types of brushes
- Liner sewn into bottom of bag to avoid flipping it when pulling hand out of the chalk bag

Product specifications

- Material(s): nylon, polyester
- Weight: 80 g

Related product(s)

SAMA
SELENA

Specifications by reference

See page 93

Rescue litter

**NEW
2021**



NEST

Litter for confined spaces

The NEST litter was developed in partnership with the French national caving rescue organization. It allows a victim to be transported horizontally, vertically or at an angle. It is easy to manipulate and simplifies installation of a victim. It is suitable for all technical rope rescue, particularly in confined spaces.

Selling points

- Allows the victim to be transported horizontally, vertically or at an angle, to adapt to irregular or narrow terrain
- Easy to manipulate:
 - litter has a complete, integrated body harness to secure the victim
 - color coding simplifies installation
 - transverse attachment points are aligned to facilitate attachment of buckles
 - quick and easy adjustment, thanks to the FAST LT PLUS automatic buckles. The locking system of the buckles limits the risk of involuntarily unfastening
 - straps are flexible and easy to use, even when wearing gloves
 - longitudinal stays and transverse plates can be removed to reduce bulk during access

- Durable:
 - handles are reinforced with high-modulus polyethylene (HMPE), for better grip and durability
 - smooth, rigid plastic bottom ensures good sliding
 - reversible comfort foam for the back of the victim limits water absorption
 - positioning foam at the thighs and feet adapts to all body types
 - durable construction, thanks to the straps being integrated through their attachment points
- Optional accessories:
 - STEF tilting device allows the litter to be easily angled according to the terrain
 - bag for storage and protection
 - pack of four longitudinal stays (reference S61904), available as spare parts

Product specifications

- Material(s): TPU, nylon, polyethylene, aluminum
- Weight: 13100 g
- Working load limit: 140 kg

Accessory(ies)

STEF (S059AA00)
Bag for NEST litter (S062AA00)

Specifications by reference: see page 94

Rescue litter

**NEW
2021**

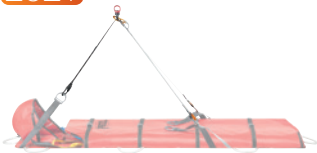

STEF

Tilting device for NEST litter

The STEF tilting device joins the three connection points of the NEST litter and allows it to be easily tilted according to the terrain. It has three Am'D TRIACT-LOCK connectors for automatic locking of the connection points, and a swivel for precise orientation of the litter.

Selling points

- Allows the litter to be easily tilted according to the terrain: horizontal, vertical or angled position
- Three Am'D TRIACT-LOCK connectors equipped with a CAPTIV positioning bar, for automatic locking of the connection points
- Swivel allows the litter to be precisely oriented
- Sm'D connector locks the litter in a horizontal position

- Orientation of use easily identified with color coding
- Attachment points for Tyrolean are separate from the vertical attachment points, to easily switch evacuation modes
- Tilting device can easily be used with a JAG SYSTEM 2 m haul kit to tilt the litter with precision

Product specifications

- Material(s): polyester, aluminum
- Weight: 640 g
- Working load limit: 140 kg

Related product(s)

NEST (S061AA00)

Specifications by reference: see page 94

Rescue litter

**NEW
2021**



Bag for NEST litter

Bag for NEST litter

The bag for the NEST litter allows it to be transported and stored. The openings at either end allow the handles of the litter to protrude, for easier handling. It is equipped with three handles and a bandolier system for easier transport.

Selling points

- For storage and protection of the litter
- Openings at either end allow the handles of the litter to protrude, for easier handling
- Velcro closure

- Three webbing-type handles and an adjustable bandolier system, for easier transport of the litter

Product specifications

Material(s): thermoplastic polyurethane (TPU)
• Weight: 1860 g

Related product(s)

NEST (S061AA00)
STEF (S059AA00)

Specifications by reference: see page 94



Cédric Lachat and Tobias Suter on the ascent of Odysee on the Eiger Nordwand © 2019 - Petzl Distribution - Guillaume Broust



KIT



CLASSIC

ACTIVE

PERFORMANCE

SPECIALIZED



Cédric Lachat and Tobias Suter on the ascent of Odysee on the Eiger Nordwand © 2019 - Pezli Distribution - Guillaume Broust

Petzl harnesses are designed to meet the needs of vertical enthusiasts, whatever their particular passion, level or body type.

Designs for all body types:

- Harnesses WITH adjustable leg loops, suitable for all body types and all seasons (winter and summer use)
- Harnesses WITHOUT adjustable leg loops for optimal lightness and freedom of movement
- Women's harnesses with contoured waistbelt, proportional rise and waistbelt/leg loop sizing

Capacity to carry gear suited to the activity:





- For gym climbing, via ferrata, glacier travel or classic mountaineering, two gear loops are sufficient
- For rock or multi-pitch climbing, four gear loops are necessary
- For activities requiring a lot of gear, such as trad climbing, technical mountaineering or ice climbing, a fifth gear loop is desirable

Harnesses for mountaineering and ski touring:

- Weight and bulk are minimized
- Practical for donning with both feet on the ground, with crampons or skis on





Product lines designed for all activities

- The PERFORMANCE line is designed for intensive, all-terrain use: high-end technical harnesses that meet the need for mobility, comfort and low weight

	Adjustable leg loops	Weight*	Number of gear loops	Gym climbing, rock climbing	Multi-pitch climbing	Trad climbing	Glacier travel, classic mountaineering	Technical mountaineering, ice climbing	Via ferrata	Ski touring
SITTA 		270 g	4 XL	●	●	●		●	●	
AQUILA 	●	345 g	4	●	●	●		●	●	
HIRUNDOS 		280 g	4	●	●			●	●	
FLY 	●	100/130 g	2 + 4 S				●	●		●

* The weight given is for size M

- The ADVANCED line is designed for active climbers and mountaineers: these comfortable harnesses can hold a lot of gear for use at the crag, on a multi-pitch route, or in the mountains. Two harnesses are specifically designed for women (♀).

	Adjustable leg loops	Weight*	Number of gear loops	Gym climbing, rock climbing	Multi-pitch climbing	Trad climbing	Glacier travel, classic mountaineering	Technical mountaineering, ice climbing	Via ferrata	Ski touring
ADJAMA 	●	485 g	5	●	●	●	●	●	●	
♀ LUNA 	●	470 g	5	●	●	●	●	●	●	
SAMA 		415 g	4	●	●		●		●	
♀ SELENA 		390 g	4	●	●		●		●	
ALTITUDE 	●	150 g	2				●			●

* The weight given is for size M-men or S-women or S/M





KIT



SPECIALIZED

Harnesses

The DISCOVER line is suitable for occasional use in climbing, ski touring or via ferrata: versatile and adjustable, these harnesses are comfortable during long suspensions and fit all body types.

		Adjustable leg loops	Weight*	Number of gear loops	Gym climbing, rock climbing	Multi-pitch climbing	Trad climbing	Glacier travel, classic mountaineering	Technical mountaineering, ice climbing	Via ferrata	Ski touring
CORAX		●	470 g	4	●	●		●	●	●	
TOUR		●	200 g	2				●			●
8003		●	580 g	2				●		●	

* The weight given is for size 1 or S/M.

Petzl harness technology

For certain climbing and mountaineering harnesses, Petzl uses specific technologies: FRAME, ENDOFRAME, FUSEFRAME or WIREFRAME. These constructions, which never sacrifice climber comfort, are adapted to the different expectations of the user, whether novice, active, or high end.



FRAME Technology

This construction forms the core of CORAX and OUISTITI harnesses, and combines a thick layer of foam with central webbing on the waistbelt and leg loops. The load is distributed by the webbing that surrounds the foam. This construction allows for great durability and comfort during prolonged suspension on a climb.

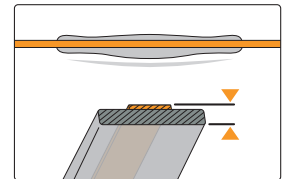

ENDOFRAME Technology

This construction combines thin foam with special (variable width) webbing sewn onto the foam for optimal load distribution. The waistbelt webbing is wider at the hips, for lightweight support. Special attention has been given to providing maximum comfort: there are no pressure points or rub points on the waistbelt. ENDOFRAME technology is used on SAMA, SELENA, ADJAMA, LUNA and MACCHU harnesses.

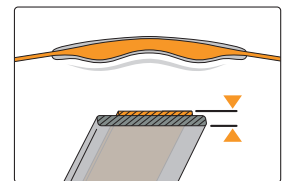

FUSEFRAME Technology



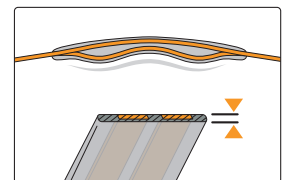



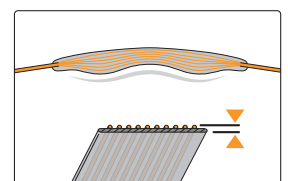

This construction uses thin thermoformed foam and doubled interior webbing for greater comfort and lightness. This gives the harnesses a smooth and clean exterior surface without adding thickness, for improved abrasion resistance. FUSEFRAME technology gives the HIRUNDOS, AQUILA and FLY harnesses (removable foam) a clean, smart design that is light and comfortable.







WIREFRAME Technology





WIREFRAME technology uses high-modulus polyethylene (HMPE) strands. These strands are used in the waistbelt and leg loops to optimally distribute pressure, ensuring maximum comfort and freedom of movement for the climber. This construction gives the harness an exceptional weight-to-comfort ratio that makes it practically unnoticeable when worn. WIREFRAME technology, applied to a very sleek design with very slim technical lines, is perfectly suited to high-performance SITTA and ALTITUDE harnesses.



		Reference	Size	Weight	Waist size	Leg loops	Made in	Case quantity	EAN code
PERFORMANCE climbing and mountaineering harnesses									
SITTA High-end climbing and mountaineering harness		C10AO S	S	240 g	67 - 77 cm	48 - 53 cm	CN	10	3342540101456
		C10AO M	M	270 g	74 - 84 cm	52 - 57 cm			3342540101449
		C10AO L	L	300 g	81 - 92 cm	55 - 60 cm			3342540101432
AQUILA Very comfortable climbing and mountaineering harness for gym, rock and multi-pitch performance climbing		C037AA00	XS	320 g	65 - 71 cm	46 - 56 cm	CN	10	3342540820623
		C037AA01	S	345 g	71 - 77 cm	48 - 58 cm			3342540820630
		C037AA02	M	365 g	77 - 84 cm	52 - 62 cm			3342540820647
		C037AA03	L	400 g	84 - 92 cm	55 - 65 cm			3342540820654
		C037AA04	XL	425 g	92 - 100 cm	57 - 67 cm			3342540820678
HIRUNDOS Lightweight and comfortable climbing harness for performance in the gym and at the crag		C036AA00	XS	260 g	65 - 71 cm	48 - 53 cm	CN	10	3342540820517
		C036AA01	S	280 g	71 - 77 cm	48 - 53 cm			3342540820524
		C036AA02	M	300 g	77 - 84 cm	52 - 57 cm			3342540820685
		C036AA03	L	320 g	84 - 92 cm	55 - 60 cm			3342540820692
		C036AA04	XL	340 g	92 - 100 cm	57 - 62 cm			3342540820708
FLY Ultra-lightweight, adaptable technical mountaineering/ski harness, dons with both feet on the ground		C002AA00	S	90/120 g	66 - 76 cm	50 - 56 cm	CN	15	3342540830943
		C002AA01	M	100/130 g	76 - 86 cm	52 - 58 cm			3342540830950
		C002AA02	L	110/140 g	86 - 96 cm	54 - 60 cm			3342540830967
ADVANCED climbing and mountaineering harnesses									
ADJAMA Climbing and mountaineering harness with adjustable leg loops, for single and multi-pitch climbing		C022BA00	S	460 g	71 - 77 cm	47 - 57 cm	CN	10	3342540835245
		C022BA01	M	485 g	77 - 84 cm	51 - 61 cm			3342540835252
		C022BA02	L	515 g	84 - 92 cm	54 - 64 cm			3342540835269
		C022BA03	XL	545 g	92 - 100 cm	56 - 66 cm			3342540835276
LUNA Women's climbing and mountaineering harness with adjustable leg loops for single and multi-pitch climbing		C035BA00	XS	440 g	65 - 71 cm	46 - 56 cm	CN	10	3342540835283
		C035BA01	S	470 g	71 - 77 cm	51 - 61 cm			3342540835290
		C035BA02	M	495 g	77 - 84 cm	54 - 64 cm			3342540835306
		C035BA03	L	525 g	84 - 92 cm	56 - 66 cm			3342540835313
SAMA Climbing harness for the gym, crag, multi-pitch routes		C021BA00	S	385 g	71 - 77 cm	48 - 53 cm	CN	10	3342540835160
		C021BA01	M	415 g	77 - 84 cm	52 - 57 cm			3342540835177
		C021BA02	L	445 g	84 - 92 cm	55 - 60 cm			3342540835184
		C021BA03	XL	475 g	92 - 100 cm	57 - 62 cm			3342540835191
SELENA Women's harness for gym, crag or multi-pitch routes		C055BA00	XS	370 g	65 - 71 cm	48 - 53 cm	CN	10	3342540835207
		C055BA01	S	390 g	71 - 77 cm	52 - 57 cm			3342540835214
		C055BA02	M	420 g	77 - 84 cm	55 - 60 cm			3342540835221
		C055BA03	L	450 g	84 - 92 cm	57 - 62 cm			3342540835238
ALTITUDE® Lightweight, compact mountaineering and ski touring harness, dons with both feet on the ground		C019AA00	S/M	150 g	64 - 86 cm	55 - 67 cm	CN	30	3342540830684
		C019AA01	M/L	160 g	74 - 96 cm	60 - 73 cm			3342540830691
		C019AA02	L/XL	170 g	84 - 108 cm	66 - 79 cm			3342540830707



	Reference	Size	Weight	Waist size	Leg loops	Made in	Case quantity	EAN code	
DISCOVER climbing and mountaineering harnesses									
CORAX Versatile and fully adjustable climbing and mountaineering harness <i>Available in 3 colors:</i> - gray: C051AAxx - blue: C051BAxx - turquoise: C051CAxx		C051AA00	1	470 g	65 - 96 cm	48.5 - 59 cm	MY	8	3342540834958
		C051AA01	2	520 g	76 - 107 cm	54 - 67 cm			3342540834965
		C051BA00	1	470 g	65 - 96 cm	48.5 - 59 cm			3342540834972
		C051BA01	2	520 g	76 - 107 cm	54 - 67 cm			3342540834989
		C051CA00	1	470 g	65 - 96 cm	48.5 - 59 cm			3342540835009
		C051CA01	2	520 g	76 - 107 cm	54 - 67 cm			3342540835016
TOUR Durable, lightweight harness for glacier travel and ski touring, dons with both feet on the ground		C020AA00	S/M	200 g	64 - 86 cm	55 - 67 cm	MY	30	3342540830813
		C020AA01	M/L	215 g	74 - 96 cm	60 - 73 cm			3342540830820
		C020AA02	L/XL	230 g	84 - 108 cm	66 - 79 cm			3342540830837
8003 Full-body harness for adults		C05 1N	1	580 g	60 - 95 cm	42 - 62 cm	RO	12	3342540025950
		C05 2 N	2	610 g	75 - 105 cm	52 - 77 cm			3342540025967
VOLTIGE Adjustable chest harness for seat harness		C60	-	280 g	-	-	RO	15	3342540001596

	Reference	Weight	Waist size	Leg loops	Specifics	Made in	Case quantity	EAN code	
Climbing harness for children									
MACCHU® Adjustable seat harness for children weighing less than 40 kg (88 lbs)		C015AA00	335 g	54 - 64 cm	34 - 44 cm	blue	VN	10	3342540825154
		C015AA01	335 g	54 - 64 cm	34 - 44 cm	violet			3342540825161
BODY Padded shoulder straps to be used in conjunction with a child's seat harness		C018BA00	150 g	-	-	chest: 45 - 80 cm	MY	15	3342540825178
OUISTITI Full-body climbing harness for children less than 30 kg		C068AA00	410 g	58 - 70 cm	32 - 40 cm	methyl blue	MY	10	3342540820432
SIMBA Full-body adjustable harness for children weighing less than 40 kg		C65	390 g	-	51 cm	torso length: 35 - 60 cm	FR	8	3342540061750

		Reference	Size	Weight	Waist size	Leg loops	Made in	Case quantity	EAN code
Caving harness									
AVEN Comfortable, durable caving harness		C013AA00	1	465 g	60-95 cm	42-62 cm	RO	5	3342540835429
		C013AA01	2	520 g	90-105 cm	52-77 cm			3342540835436
SUPERAVANTI Durable, lightweight caving harness		C012AA00	1	410 g	60 - 95 cm	42 - 62 cm	RO	5	3342540835405
		C012AA01	2	450 g	90 - 105 cm	52 - 77 cm			3342540835412
EXPLO Shoulder straps for positioning a CROLL, with gear loops		C027AA00	-	170 g	-	-	CN	6	3342540835450
TORSE Shoulder straps for positioning a CROLL		C026AA00	-	90 g	-	-	RO	6	3342540835443
Canyoning harnesses									
CANYON CLUB Easy-to-use harness with integrated protective seat, for canyoning		C086AA00	-	660 g	60 - 120 cm	40 - 75 cm	KH	10	3342540829886
CANYON GUIDE Comfortable, ergonomic harness with integrated protective seat, for canyoning		C086BA00	1	870 g	65 - 95 cm	40 - 65 cm	CN	5	3342540829893
		C086BA01	2	920 g	75 - 120 cm	40 - 75 cm			3342540829909
Protective seat for CANYON harnesses		C086CA00	-	160 g	-	-	KH	10	3342540830011
		C086CA01							3342540830035
		C086CA02							3342540830042
Comfort foam for CANYON CLUB harness		C086FA00	-	105 g	-	-	CN	10	3342540830059
Gear loop for CANYON CLUB harness		C086GA00	-	25 g	-	-	CN	20	3342540830066
Cutaway sling for CANYON CLUB harness		C086DA00	-	9 g	-	-	FR	40	3342540830004
Cutaway sling for CANYON GUIDE harness		C086EA00	-	7 g	-	-	FR	40	3342540830615
Harness accessories									
CARITool Harness tool holder		P42	-	25 g	-	-	IT	30	3342540063877
CARITool EVO Universal holder for ice screws and tools, suitable for all types of harnesses		P42 M	-	50 g	-	-	IT	30	3342540817364





Jules Buteau on *L'Angle Desmazon*, 6a+, Caroux, France. © 2019 Petzl Distribution - Sam Blé

Petzl, beyond the standards

Petzl goes above and beyond the standard requirements for all our helmets, offering effective protection against falling objects and side, front and rear impacts.

TOP AND SIDE PROTECTION: what are the levels of protection?

1. Standard protection

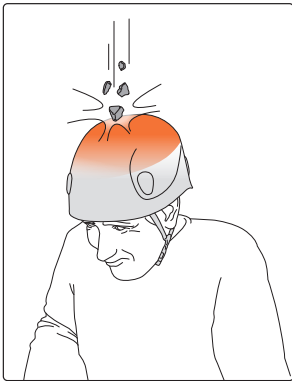

Standard protection against falling objects (rocks, ice...)

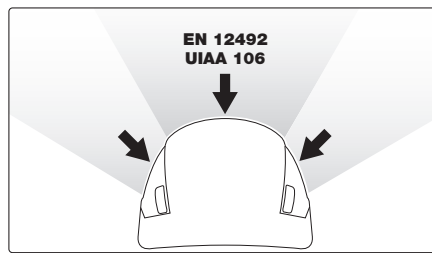

EN 12492 / UIAA 106 standard tests

2. Enhanced protection



Enhanced protection against falling objects and against side, front, and rear impacts

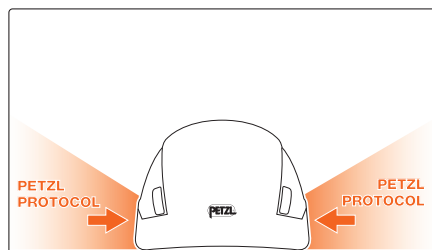

Supplementary tests performed by Petzl

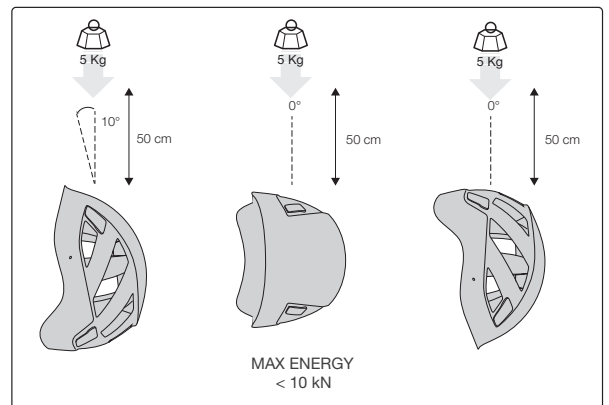

1. Standard protection + 2. Enhanced protection

TOP AND SIDE PROTECTION

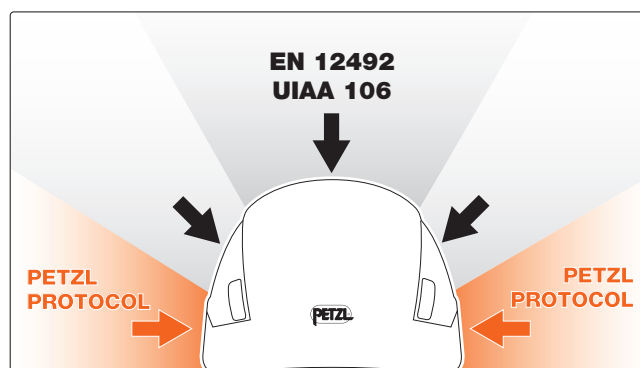
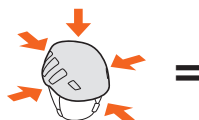

Climbing and mountaineering helmets with CE ski touring helmet certification

With protection against falling objects (EN 12492) and enhanced protection against lateral, front or rear impact (Petzl's TOP AND SIDE PROTECTION label), Petzl helmets efficiently protect the head during numerous activities: climbing, mountaineering, and now ski touring, where wearing a helmet is not yet the norm.

What are the different requirements for a ski touring helmet?

Ventilation:

In ski touring, the physical effort generated on the climb is considerable and requires appropriate gear. Only a lightweight, and most importantly, ventilated helmet can be comfortably worn from beginning to end of an outing.

Head protection:

Throughout a ski touring day, climbing or descending, the skier may face any of the following risks:

- rockfall:



As in mountaineering, the skier may be exposed to rock or icefall, for example when climbing a couloir.

- side, front, and rear impacts:



A fall while climbing, on a steep or frozen slope, above a rocky outcrop.

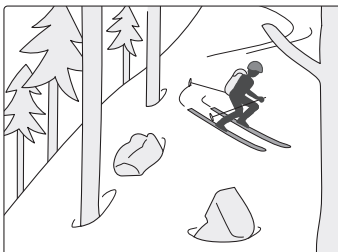

A fall while descending, caused by hazards on the terrain: rocks, trees, ice blocks, crevasses, avalanches...

The best balance of ventilation and protection for the head will encourage participants to wear a helmet from beginning to end of an outing.

Why has Petzl pursued the creation of a new CE certification for ski touring helmets?

Currently there is no reference standard outlining the health and safety requirements for a ski touring helmet, unlike downhill skiing, which follows the guidelines of the EN 1077 class B standard.

Therefore, in order to obtain CE certification for a helmet used for ski touring, Petzl approached a certified body to create a standard that takes into consideration the practice, the environment and the dangers of ski touring. This reference standard is based primarily on:

- The requirements of the mountaineering helmet standard (EN 12492), to provide rockfall protection while ensuring maximum ventilation for comfortable wear during ascents
- Requirements for enhanced protection against lateral, front and rear impacts (as described in Petzl's test protocol for the TOP AND SIDE PROTECTION label).

This new reference standard is the PCSR-001 (Protocol for ski touring helmets). It is public, and available to other manufacturers for certification of their helmets.

Choosing your helmet

	PERFORMANCE	ADVANCED	DISCOVER		CHILDREN	CAVING
	SIROCCO® 	METEOR 	BOREO® 	BOREA 	PICCHU 	BOREO® CAVING
TOP AND SIDE PROTECTION	•	•	•	•	•	•
CE certified ski touring helmet	•	•	-	-	-	-
Weight (size M/L)	170 g	220 g	295 g	295 g	330 g	335 g
Detail	ultra-lightweight	versatile	durable	designed for women	climbing and cycling	with mounts for DUO headlamps
Ventilation	★★★	★★★	★★	★★	★	★★

Petzl helmet construction

Manufacturing	Principle of shock absorption	Petzl helmets
Hybrid EPP foam shell and EPS foam liner injected under a thin polycarbonate crown	The crown protects the liner and helps stop sharp objects at the top of the helmet. The liner alone absorbs top impacts by deformation. The shell alone absorbs side, front and rear impacts by deformation.	SIROCCO®
In-Mold EPS foam liner injected under a thin polycarbonate shell	The shell protects the liner and helps stop sharp objects. The liner alone absorbs impacts by deformation.	METEOR
Hard shell / Hybrid Hard ABS shell protects the EPP and/or EPS foam liner	The shell protects the liners, helps stop sharp objects and distributes impacts. The liners absorb impacts by deformation.	BOREO® BOREA PICCHU







EPP: expanded polypropylene
 EPS: expanded polystyrene
 ABS: acrylonitrile butadiene styrene





KIT



SPECIALIZED

	Reference	Color	Size	Weight	Head circumference	Made in	Case quantity	EAN code			
PERFORMANCE climbing and mountaineering helmets											
SIROCCO® Ultra-lightweight helmet with enhanced protection for climbing, mountaineering and ski touring 	A073AA00	white/orange	S/M	160 g	48 - 58 cm	CN	8	3342540818187			
	A073AA01		M/L	170 g	53 - 61 cm			3342540818323			
	A073BA00	black/orange	S/M	160 g	48 - 58 cm			3342540818330			
	A073BA01		M/L	170 g	53 - 61 cm			3342540818194			
ADVANCED climbing and mountaineering helmet											
METEOR Lightweight helmet with enhanced protection for climbing, mountaineering and ski touring 	A071AA00	gray	S/M	225 g	48 - 58 cm	CN	8	3342540825901			
	A071AA01		M/L	240 g	53 - 61 cm			3342540826014			
	A071AA02	red	S/M	225 g	48 - 58 cm			3342540825888			
	A071AA03		M/L	240 g	53 - 61 cm			3342540825895			
	A071AA04	violet	S/M	225 g	48 - 58 cm			3342540825864			
	A071AA05		M/L	240 g	53 - 61 cm			3342540825871			
DISCOVER climbing and mountaineering helmets											
BOREO® Durable and versatile helmet with enhanced protection for climbing and mountaineering 	A042FA00	blue	S/M	285 g	48 - 58 cm	FR	8	3342540830912			
	A042FA01		M/L	295 g	53 - 61 cm			3342540830929			
	A042GA00	orange	S/M	285 g	48 - 58 cm			3342540830875			
	A042GA01		M/L	295 g	53 - 61 cm			3342540830882			
	A042HA00	red	S/M	285 g	48 - 58 cm			3342540830899			
	A042HA01		M/L	295 g	53 - 61 cm			3342540830905			
	A042AA00	white	S/M	285 g	48 - 58 cm			3342540820029			
	A042AA01		M/L	295 g	53 - 61 cm			3342540820036			
	A042EA00	gray	S/M	285 g	48 - 58 cm			3342540826120			
	A042EA01		M/L	295 g	53 - 61 cm			3342540826137			
	BOREA Durable and versatile helmet with enhanced protection, for women 	A048AA00	white	-	295 g			52 - 58 cm	FR	8	3342540830844
		A048BA00	turquoise								3342540830868
A048CA00		violet				3342540830851					
Children's climbing and cycling helmet											
PICCHU NEW 2021 Children's climbing and cycling helmet with enhanced protection 	A049AA00	blue	-	330 g	48 - 54 cm	PT	8	3342540829541			
	A049AA01	violet						3342540830462			
Caving helmet											
BOREO® CAVING Caving helmet with mounting plates for DUO headlamp 	A042SA00	white	S/M	325 g	48 - 58 cm	FR	8	3342540820722			
	A042SA01		M/L	335 g	53 - 61 cm			3342540820739			

	Reference	Weight	Made in	Case quantity	EAN code
Helmet accessories					
Absorbent replacement foam Absorbent replacement foam 	A042MA00	10 g	IT	50	3342540820937
Non-absorbent replacement foam Non-absorbent replacement foam 	A042MA01	10 g	IT	50	3342540820944



KIT



CLASSIC



PERFORMANCE



SPECIALIZED



Petzl belay/rappel devices: standard usage techniques

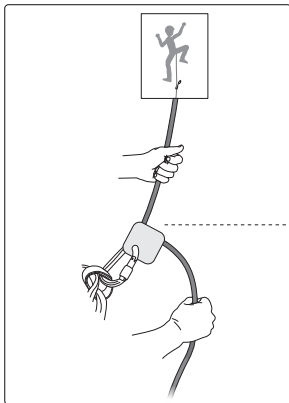

Hand positioning

This hand position is valid regardless of the device used.

Your hand must never let go of the brake side of the rope.

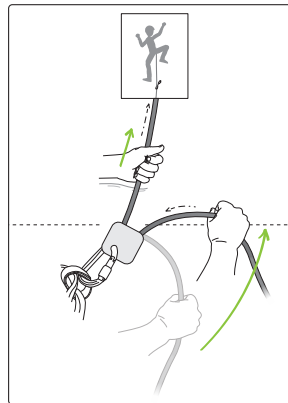

Giving slack

To give slack, your brake-side hand pushes the rope towards the device, creating slack; your other hand pulls the rope through the device.

To repeat this movement, slide your brake-side hand along the rope, without ever letting it go.

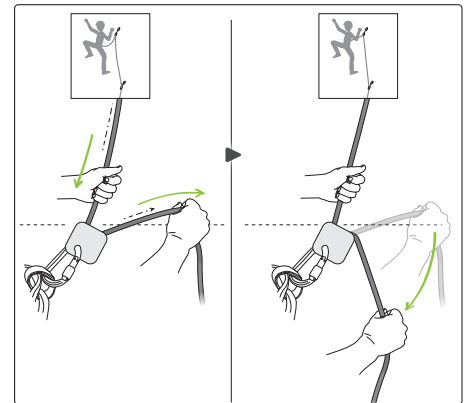

Taking up slack

To take up slack, pull in the climber-side rope and pull the brake-side rope through the device. Never let go of the brake side of the rope.

Even though this hand sequence is common to all belay systems, **the position and the tightness of the grip of the brake-side hand are determined by the function and performance of the belay device.** These two features also affect the comfort of the belay.

Petzl belay systems: three types of devices

Belay devices with cam-assisted blocking

• Working principle

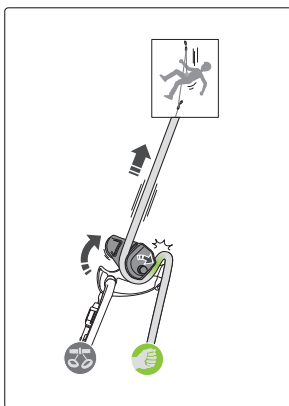

When a climber falls or rests, the rope tightens, and the cam pivots to pinch the rope and block it.

• Benefits:

- **comfortable belay, thanks to cam-assisted blocking**, which minimizes the strength required of the brake-side hand. This system is especially useful for working a route: trying a move over and over, holding the climber...
- **considerable leeway for brake-side hand position**, regardless of the angle between the climber-side and brake-side ropes
- **exceptionally comfortable descent**, thanks to the ergonomic handle that controls the progressive rope feed



GRIGRI® +

Belay device with cam-assisted blocking and anti-panic handle, particularly suitable for learning and for intensive use



GRIGRI®

Belay device with cam-assisted blocking



Belay devices and descenders

Assisted braking belay device

- Working principle

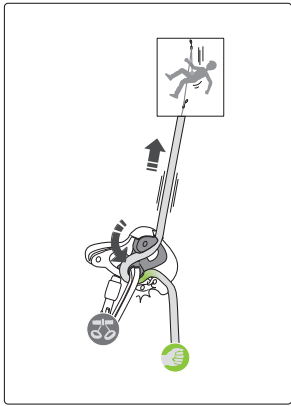

When a climber falls or rests, the rope tightens, engaging the moving brake plate, which causes it to press the rope against the fixed brake plate.

- Advantages

- **very smooth, for giving slack quickly without touching the device**
- **comfortable belaying, thanks to the assisted braking**, which greatly reduces the strength required of the brake-side hand
- **effective braking, regardless of carabiner cross-section**



YSI (easy)
Assisted braking belay device

Belay/rappel devices

- Working principle

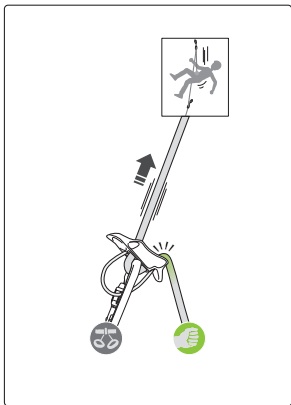

When a climber falls or rests, the brake hand grips the rope firmly and pulls it downward, the rope gets pressed into the braking grooves, thus increasing the friction until the rope stops.

- Advantages

- **simple, compact and lightweight**
- **compatible with single, half, and twin dynamic ropes**
- **comfortable rappels**, thanks to the efficiency of the braking grooves







REVERSO®
Versatile, lightweight belay/rappel device, for use with one or two rope strands to belay a second climber from the anchor



VERSO
Compact, lightweight belay/rappel device, for use with one or two rope strands and for rappelling

Choosing your belay device

	 GRIGRI® +	 GRIGRI®	 YSI (easy)	 REVERSO®	 VERSO
Type of device	assisted blocking belay devices		assisted braking belay device	belay/rappel devices	
Leeway for brake-side hand position					
Strength required of brake-side hand					
Specifics	anti-panic handle and top-rope mode	comfortable descent	very smooth, for giving slack quickly without touching the device	belaying a second climber from the anchor and rappelling on two rope strands	compact, lightweight and for rappelling on two rope strands
Weight	200 g	175 g	125 g	57 g	55 g



KIT













CLASSIC







ACTIVE

PERFORMANCE

SPECIALIZED

Belay devices and descenders

		Reference	Color	Weight	Rope diameter	Made in	Case quantity	EAN code
Assisted blocking belay devices								
GRIGRI® + Belay device with cam-assisted blocking and anti-panic handle, particularly suitable for learning and for intensive use		D13A G	gray	200 g	8.5 to 11 mm single rope	FR	17	3342540106536
		D13A AG	orange					3342540106543
		D13A VI	violet					3342540106550
GRIGRI® Belay device with cam-assisted blocking		D014BA00	gray	175 g	8.5 to 11 mm single rope	FR	17	3342540825536
		D014BA01	red/orange					3342540825543
		D014BA02	blue					3342540825550
Assisted braking belay device								
YSI (easy) Assisted braking belay device		D018AA00	gray	125 g	8.5 to 11 mm single rope	FR	17	3342540834231
			blue					3342540834248
		D018AA02	turquoise					3342540834255
Belay/rappel devices								
REVERSO® Versatile, lightweight belay/rappel device, for use with one or two rope strands to belay a second climber from the anchor		D017AA00	gray	57 g	ropes: - single: 8.5 to 10.5 mm - half: 7.1 to 9.2 mm - twin: 6.9 to 9.2 mm	GB	18	3342540825918
		D017AA01	green					3342540825932
		D017AA02	red/orange					3342540825925
VERSO Compact, lightweight belay/rappel device, for use with one or two rope strands, and for rappelling		D019AA00	gray	55 g	ropes: - single: 8.5 to 11 mm - half: 7.1 to 9.2 mm - twin: 6.9 to 9.2 mm	GB	18	3342540825949
		D019AA01	green					3342540825956
Descenders								
HUIT Figure-eight descender		D02	gray	100 g	8 to 13 mm rope	FR	15	3342540010499
HUIT ANTIBRULURE Figure-eight descender with anti-burn tab		D01	black	110 g	8 to 13 mm rope	FR	15	3342540001749
Caving descenders								
STOP Assisted braking descender for caving		D009AA00	blue	350 g	8.5 to 11 mm low stretch kernmantel rope	FR	10	3342540828551
SIMPLE Simple, lightweight descender for caving		D004AA00	red	240 g	8.5 to 11 mm low stretch kernmantel rope	FR	15	3342540828568
RACK Brake bar descender for long descents		D11	-	470 g	low stretch kernmantel rope - one rope strand: 9 to 13 mm - two rope strands: 8.5 to 11 mm	FR	25	3342540002067
FREINO Z Automatic locking carabiner with friction spur for STOP and SIMPLE descenders		M042AA00	-	75 g	-	GB	25	3342540828575

	Reference	Color	Weight	Rope diameter	Made in	Case quantity	EAN code
Pulley for SIMPLE Pulley for SIMPLE caving descender 	D004CA00	-	52 g	-	FR	50	3342540828582
Swinging brake bar with hook for RACK 	D11250	-	-	-	FR	50	3342540002104
Brake bar w/o hook for RACK 	D11200	-	-	-	FR	50	3342540002098
Anodized, fixed brake bar for RACK 	D11300	-	-	-	FR	50	3342540002111
Canyoning descender							
PIRANA Adjustable friction descender for canyoning  	D005AA00	orange	110 g	8 to 13 mm rope	IT	10	3342540830073
	D005AA01	black					3342540830080





Steve McClure belaying Fabian Bhui, Frankenjura, Germany © 2019 - Petzl Distribution - Frank Kretschmann

Types of ropes

Dynamic ropes

Single ropes ①

Ropes used as a single strand. These are mainly used for single-pitch climbing. Some climbers also use them for multi-pitch climbing or mountaineering.

Half ⑫ and twin ⑩ ropes

These are certified to two types of the CE EN 892 standard.

- Half ropes: ropes used in pairs that may be clipped separately or together during progression. They are recommended for rappels and to facilitate rope drag management. They provide extra safety in case one of the strands is cut by a falling rock or a sharp edge
- Twin ropes: ropes used in pairs that, unlike half ropes, must always be clipped together during progression. They are recommended for rappels

Multi-type ropes

Multi-type ropes are certified to three types of the CE EN 892 standard. They may be used as a single, half or twin rope.

Low stretch kernmantel ropes

Low stretch kernmantel ropes have low elongation and are very resistant to abrasion. They are designed for caving, canyoning, rope ascent or hauling, as well as for bolting a route.

Manufacture, finish and treatment: Petzl's choices



UIAA Guide Dry Treatment

The UIAA Guide Dry treatment is our most complete water repellent treatment for frequent use in wet environments. It makes a difference especially for regular use in extreme environments: ice climbing, mountaineering. This treatment also improves the rope's resistance to dirt and abrasion.

The UIAA Guide Dry treatment meets the requirements of the UIAA Water Repellent test. The results of this test indicate water absorption of less than 2 %.

The manufacturing process for UIAA Guide Dry treatment has two stages: the core is treated before the rope is braided, and then the entire rope is treated in order to minimize water absorption and penetration of fine particles into the rope.



Duratec Dry Treatment

Dry treatment, making the rope more resistant to water, dirt and abrasion. Handling, grip and other characteristics are retained longer in cold, wet conditions.



EverFlex Treatment

Special treatment stabilizes the core strands and improves consistency. Provides excellent grip and handling over time.



UltraSonic Finish

Ultrasonic welding bonds the core and sheath together at the rope ends. Gives greater durability and avoids frayed ends.



ClimbReady Coil

Specific coil makes the rope ready to use. Helps the user avoid initial uncoiling mistakes, and increases longevity.















Middle Mark

Indicates the middle of the rope, to facilitate maneuvers.



Choosing your single dynamic rope

						
	VOLTA® GUIDE 9 mm	VOLTA® 9.2 mm	ARIAL® 9.5 mm	CONTACT® 9.8 mm	CONTACT® WALL 9.8 mm	MAMBO® 10.1 mm
Rope type	Multi-type rope		Single rope			
 Guide UIAA Dry	•					
 Duratec Dry		•	•			
 EverFlex	•	•	•	•	•	•
 UltraSonic Finish	•	•	•	•	•	•
 ClimbReady	•	•	•	•	•	•
 Middle Mark	•	•	•	•	•	•
Ice climbing, mixed climbing	★★★	☆	☆			
Mountaineering	★★★	★★				
Glacier travel	★★★	★				
Multi-pitch climbing	☆	☆	☆	☆		
High-end rock climbing	★★★	★★★	★★★	★		
Rock climbing	★	★★	★★★	★★★		★★★
Gym climbing			★	★★	★★★	★★★











★★★ Recommended use

★★ Suitable use

★ Possible use

☆ Possible use: should be used with a second rope for rappelling, if required.

Choosing your half or twin dynamic rope

					
	PASO® GUIDE 7.7 mm	RUMBA® 8 mm	TANGO® 8.5 mm	VOLTA® GUIDE 9 mm	VOLTA® 9.2 mm
Rope type	Half rope and twin rope			Multi-type rope	
 Guide UIAA Dry	•			•	
 Duratec Dry		•			•
 EverFlex	•	•	•	•	•
 UltraSonic Finish	•	•	•	•	•
 ClimbReady	•	•	•	•	•
 Middle Mark	•	•	•	•	•
Ice climbing, mixed climbing	★★★	★★		★★★	☆
Mountaineering	★★★	★★★		★★★	★★
Glacier travel				★★★	★
Multi-pitch climbing	★	★★★	★★★	☆	☆

★★★ Recommended use









★★ Suitable use

★ Possible use

☆ Possible use: should be used with a second rope for rappelling, if required.









Choosing your low stretch kernmantel rope







	 CLUB 200 10 mm	 CLUB 10 mm	 PUSH 200 9 mm	 PUSH 9 mm				
Lengths available	200 m	40 m 60 m 70 m	200 m	40 m 60 m 70 m				
 Everflex	•	•	•	•	•	•	•	•
 UltraSonic Finish		•	•	•		•	•	•
 ClimbReady		•	•	•		•	•	•
 Middle Mark		•	•	•		•	•	•
Independent caving	★	★	★	★	★★★★	★	★	★
Independent canyoning	★	★	★	★	★	★★★★	★★★★	★★★★
Guided caving / canyoning	★★★★	★★★★	★★★★	★★★★	★	★	★	★
Big wall / fixed rope	★★★★	★	★	★	★			
Hauling a person						★★★★	★★★★	★★★★
Self-belay climbing on fixed rope	★	★★★★	★★★★	★★★★				
Route bolting	★★★★							







★★★★ Ideal use





★ Possible use

	Reference	Length	Color	Weight per meter	Made in	Case quantity	EAN code
Dynamic single ropes							
VOLTA® GUIDE 9 mm NEW 2021 Ultra-lightweight multipurpose 9 mm rope with UIAA Guide Dry treatment, for ultimate climbing and mountaineering performance 	R36AO 030	30 m	orange	54 g	DE	4	3342540106215
	R36AO 040	40 m				3	3342540817654
	R36AO 050	50 m				3	3342540106239
	R36AO 060	60 m				3	3342540106222
	R36AO 080	80 m				2	3342540833937
	R36AO 100	100 m				2	3342540823211
VOLTA® 9.2 mm Ultra-lightweight multi-type 9.2 mm rope for performance climbing and mountaineering 	R35AO 030	30 m	orange	55 g	DE	4	3342540099128
	R35AN 050	50 m	gray			3	3342540096806
	R35AO 050		orange				3342540096813
	R35AN 060	60 m	gray			2	3342540096820
	R35AO 060		orange				3342540096837
	R35AN 070	70 m	gray			2	3342540096844
	R35AO 070		orange				3342540096851
	R35AN 080	80 m	gray			2	3342540096868
	R35AO 080		orange				3342540096875
	R35AO 100	100 m	orange			2	3342540096882
ARIAL® 9.5 mm NEW 2021 Lightweight and durable 9.5 mm single rope with Duratec Dry treatment for climbing and alpinism 	R34AC 060	60 m	red	58 g	DE	2	3342540833876
	R34AD 060		blue				3342540833906
	R34AC 070	70 m	red				3342540833883
	R34AD 070		blue				3342540833913
	R34AC 080	80 m	red				3342540833890
	R34AD 080		blue				3342540833920
CONTACT® 9.8 mm NEW 2021 9.8 mm diameter lightweight single rope for gym or rock climbing 	R33AC 060	60 m	blue	60 g	DE	2	3342540833814
	R33AD 060		green				3342540833845
	R33AC 070	70 m	blue				3342540833821
	R33AD 070		green				3342540833852
	R33AC 080	80 m	blue				3342540833838
	R33AD 080		green				3342540833869
CONTACT® WALL 9.8 mm NEW 2021 9.8 mm diameter lightweight single rope for gym climbing 	R33AC 030	30 m	blue	60 g	DE	2	3342540835139
	R33AD 040	40 m	green				3342540835146
MAMBO® 10.1 mm NEW 2021 10.1 mm diameter single rope with good grip for gym or rock climbing 	R32AC 050	50 m	turquoise	65 g	DE	2	3342540833753
	R32AD 050		green				3342540833784
	R32AC 060	60 m	turquoise				3342540833760
	R32AD 060		green				3342540833791
	R32AC 070	70 m	turquoise				3342540833777
	R32AD 070		green				3342540833807



	Reference	Length	Color	Weight per meter	Made in	Case quantity	EAN code
Dynamic half ropes							
PASO® GUIDE 7.7 mm 7.7 mm diameter half rope with UIAA Guide Dry treatment for technical mountaineering and ice climbing 	R22BG 050	50 m	gray	40 g	DE	4	3342540106031
	R22BO 050		orange				3342540106000
	R22BG 060	60 m	gray	3		3342540106048	
	R22BO 060		orange			3342540106017	
	R22BG 070	70 m	gray	3		3342540106055	
	R22BO 070		orange			3342540106024	
RUMBA® 8 mm 8 mm diameter half rope with Duratec Dry treatment for multi-pitch climbing and mountaineering 	R21BR 050	50 m	red	44 g	DE	4	3342540106260
	R21BB 050		blue				3342540106253
	R21BR 060	60 m	red			3	3342540106277
	R21BB 060		blue				3342540106246
TANGO® 8.5 mm 8.5 mm diameter half rope for multi-pitch climbing and mountaineering on rock 	R20AW 050	50 m	white/blue	47 g	DE	3	3342540096899
	R20AB 050		yellow				3342540096905
	R20AW 060	60 m	white/blue			2	3342540096912
	R20AB 060		yellow				3342540096929
Low stretch kernmantel ropes							
PUSH 9 mm 9 mm diameter low stretch kernmantel rope designed for independent caving and canyoning 	R40AO 040	40 m	orange	56 g	CZ	3	3342540104761
	R40AW 040		white				3342540817647
	R40AO 060	60 m	orange			2	3342540104778
	R40AO 070		70 m				orange
PUSH 200 9 mm 9 mm diameter low stretch kernmantel rope designed for independent caving and canyoning 	R40AO 200	200 m	orange	56 g	CZ	1	3342540104617
	R40AW 200	200 m	white				3342540104594
CLUB 10 mm 10 mm diameter low stretch kernmantel rope designed for caving and canyoning 	R39AO 040	40 m	orange	69 g	CZ	3	3342540104471
	R39AW 040		white				3342540817630
	R39AO 060	60 m	orange			2	3342540104464
	R39AO 070		70 m				orange
CLUB 200 10 mm 10 mm diameter low stretch kernmantel rope designed for caving and canyoning 	R39AO 200	200 m	orange	69 g	CZ	1	3342540104488
	R39AW 200	200 m	white				3342540104495

	Reference	Diameter	Length	Color	Weight per meter	Made in	Case quantity	EAN code
Technical cords								
PUR LINE 6 mm Ultra-lightweight and ultra-durable hyperstatic cord designed for climbers and alpinists, for hauling packs and retrieving single ropes during rappels  	R010AA00	6 mm	65 m	white/orange	20 g	CZ	-	3342540832589
	R010AA01		200 m				-	3342540832596
RAD LINE 6 mm Ultra-light and compact hyperstatic cord, designed for skiers doing crevasse rescue, rappelling or roping up on a glacier to get out of a crevasse zone 	R011AA00	6 mm	30 m	orange	22 g	CZ	3	3342540832602
	R011AA01		60 m				4	3342540832619
SEGMENT 8 mm Accessory cord designed for expert caving 	R076AA06	8 mm	200 m	white	43 g	CZ	1	3342540817111
Kits								
RAD SYSTEM A complete ultra-lightweight and compact kit with special cord, designed for skiers for crevasse rescue, rappelling, or roping up on a glacier to get out of a crevasse zone 	K011AA00	-	30 m	orange	1000 g	CZ	3	3342540832626
Cords								
Cords Semi-static cords in 120-meter rolls 	R044AA00	4 mm	120 m	orange	10 g	FR	5	3342540820784
	R045AA00	5 mm		red	15 g		4	3342540820852
	R046AA00	6 mm		green	24 g		2	3342540820791
	R047AA00	7 mm		blue	31 g		2	3342540820869
Technical hiking cord								
CONGA® 8 mm 8 mm diameter cord for installing a handline when on a hike 	R42AB 020	8 mm	20 m	blue	43 g	FR	15	3342540098381
	R42AB 030		30 m				10	3342540098374

	Reference	Color	Weight	Specifics	Made in	Case quantity	EAN code
Rope bags							
KAB Rope bag for gym climbing 	S011AA00	gray	880 g	Volume: 20 to 26 liters	VN	10	3342540825789
KLIFF Climbing pack with integrated rope tarp 	S010AA00	gray	750 g	Volume: 36 liters	VN	10	3342540825796
	S010AA01	red/orange					3342540825802
TARP Large rope tarp  	S012AA00	black	280 g	Dimensions: 140 x 140 cm	-	10	3342540835153





Features of Petzl carabiners

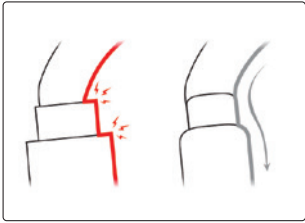

Fluid interior design

The fluid interior design of Petzl locking carabiners limits the risk of having a catch point and facilitates rotation of the carabiner.



H-shaped cross-section

The carabiners have an H-shaped cross-section that ensures an optimal strength/weight ratio, protects the markings from abrasion, and offers excellent handling, even when wearing gloves.

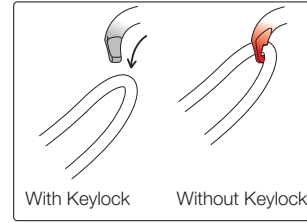

Keylock system

To ensure optimal efficiency, all Petzl carabiners use the Keylock system: the body/gate interface does not have a hook that could snag on anchors, ropes, harness gear loops...

Locking carabiners

Shapes and uses

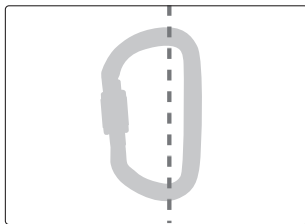

D shape

D-shaped carabiners are the most versatile and are efficient in any situation.

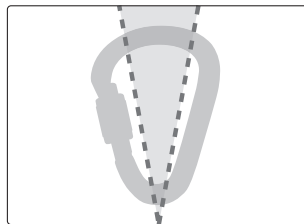

Pear shape

These carabiners have a large capacity and are recommended when using a Munter hitch or for storing gear.

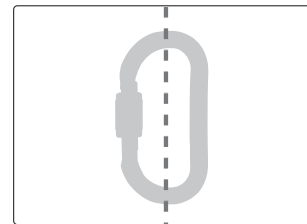

Oval shape

These carabiners are designed for use with pulleys and progress-capture pulleys.

Locking systems

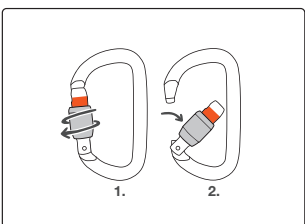

SCREW-LOCK

Easily opened, can be locked or not according to user needs. The red band provides a visual warning when the carabiner is unlocked. This system is suitable for harsh environments where contaminants (mud, ice) could cause an automatic locking system to jam.

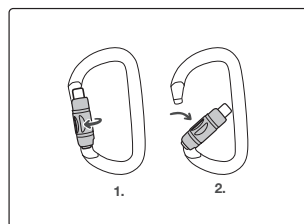

TWIST-LOCK

Automatic locking system designed for very frequent handling, for use at the end of a lanyard or to connect a GRIGRI belay device to the harness. Double-action opening by turning the sleeve, then pressing on the gate.

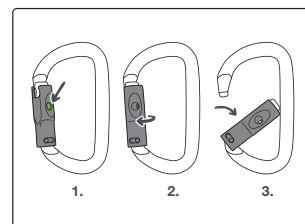

BALL-LOCK

Automatic locking system designed for frequent handling. Triple-action opening by pressing on the green indicator, turning the sleeve, then pressing on the gate. The green button indicates when the gate is locked.

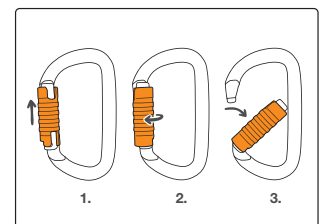

TRIACT-LOCK

Auto-locking system Triple-action opening by raising and turning the sleeve, then pressing on the gate.



Carabiners and quickdraws

Non-locking carabiners



MonoFil Keylock gate

Very light due to MonoFil technology, these carabiners provide a very smooth clip. The Keylock system facilitates unclipping.



Classic straight gate with textured area

The textured area improves grip when opening the carabiner.

Quickdraws



Quickdraw slings are available in two or three lengths, to reduce rope drag in certain situations: small roofs, overhangs, offset anchor points...



All quickdraws come with a STRING to maintain the proper orientation of the carabiner and facilitate clipping.

Choosing the right Petzl quickdraws for your use



ANGE FINESSE for low weight

Designed for mountaineering and situations where every gram counts, ANGE FINESSE quickdraws are ultra-light and compact. Available in two lengths and two carabiner sizes.



SPIRIT EXPRESS for greater versatility

A compromise between low weight and ergonomics, SPIRIT EXPRESS quickdraws are suitable for working routes at the crag or on a multi-pitch climb. Available in two lengths.









DJINN AXESS for optimal durability



Combining durability with good handling, DJINN AXESS quickdraws are designed for rock climbing. Available in two lengths.

	Reference	Version	Weight				Made in	Case quantity	EAN code	
Locking carabiners										
WILLIAM Large, pear-shaped locking carabiner for belay stations and belaying with a Munter hitch		M36A SL	SCREW-LOCK	85 g	27 kN	8 kN	8 kN	FR	20	3342540102361
		M36A BL	BALL-LOCK	90 g						3342540102316
Am'D D-shaped locking carabiner for attaching devices to a harness		M34A SL	SCREW-LOCK	70 g	27 kN	8 kN	7 kN	FR	20	3342540102477
		M34A BL	BALL-LOCK	75 g						3342540102422
		M34A RL	TWIST-LOCK	75 g						3342540102392
Sm'D Highly versatile, lightweight, compact, D-shaped locking carabiner		M39A SL	SCREW-LOCK	46 g	23 kN	8 kN	7 kN	FR	20	3342540817524
		M39A RL	TWIST-LOCK	51 g						3342540817548
OK Oval carabiner for use with pulleys and ascenders		M33A SL	SCREW-LOCK	70 g	25 kN	8 kN	7 kN	FR	20	3342540815810
		M33A TL	TRIACT-LOCK	75 g						3342540815834
		M33A BL	BALL-LOCK	75 g						3342540815858
ATTACHE Lightweight, compact, pear-shaped screw-lock carabiner		M38A SL	SCREW-LOCK	56 g	22 kN	7 kN	6 kN	FR	20	3342540097711
SPIRIT SCREW-LOCK Compact, ultra-lightweight screw-lock carabiner		M53A SL	SCREW-LOCK	45 g	23 kN	8 kN	9 kN	FR	20	3342540097650
Special locking carabiners										
FREINO Carabiner with friction spur for descenders		M42	TWIST-LOCK	85 g	25 kN	10 kN	9 kN	GB	25	3342540061859
OMNI Semi-circle carabiner for closing a harness		M37 SL	SCREW-LOCK	86 g	20 kN	15 kN	7 kN	IT	30	3342540071957
		M37 TL	TRIACT-LOCK	92 g						3342540071971
VERTIGO WIRE-LOCK Carabiner for progression lanyard		M40A WLU	WIRE-LOCK	95 g	25 kN	10 kN	8 kN	IT	25	3342540097179
Non-locking carabiners										
ANGE S Ultra-light, compact carabiner with MonoFil Keylock gate		M57 O	orange	28 g	20 kN	7 kN	9 kN	FR	28	3342540088986
		M57 G	light gray							3342540088979
ANGE L Lightweight carabiner with MonoFil Keylock gate		M59 B	blue	34 g	22 kN	7 kN	10 kN	FR	28	3342540088993
		M59 G	dark gray							3342540089006







Carabiners and quickdraws

	Reference	Version	Weight				Made in	Case quantity	EAN code
SPIRIT Versatile, lightweight carabiner for sport climbing, available in straight and bent gate versions 	M53 S	straight gate	39 g	23 kN	8 kN	9 kN	FR	28	3342540093157
	M53 B	bent gate							3342540093140
DJINN Durable carabiner for rock climbing, available in straight and bent gate versions 	M060AA00	straight gate gray	45 g	23 kN	8 kN	9 kN	FR	28	3342540825611
	M060BA00	bent gate blue							3342540825628
	M060BA01	bent gate violet							3342540825635
Sm'D WALL Compact, lightweight D-shaped carabiner for progression when aid climbing and for connecting accessories 	M39A S	-	41 g	23 kN	8 kN	7 kN	FR	20	3342540817531

	Reference	Sling length	Weight	Carabiner		Sling strength	Made in	Case quantity	EAN code
				upper	lower				
Quickdraws									
ANGE FINESSE Ultra-light quickdraw for mountaineering 	M057AA00	10 cm	63 g	ANGE S	ANGE S	22 kN	FR	10	3342540825192
	M057AA01	17 cm	66 g	ANGE S	ANGE S				3342540825208
	M057BA00	17 cm	72 g	ANGE S	ANGE L				3342540825512
	M057CA00	17 cm	78 g	ANGE L	ANGE L				3342540825529
SPIRIT EXPRESS Lightweight, versatile quickdraw for sport climbing 	M053AA00	11 cm	93 g	SPIRIT straight	SPIRIT bent	22 kN	FR	20	3342540825475
	M053AA01	17 cm	100 g						3342540825482
DJINN AXESS Durable quickdraw for rock climbing 	M060CA01	12 cm	107 g	DJINN straight	DJINN bent, violet	22 kN	FR	20	3342540825444
	M060CA00	12 cm	107 g		DJINN bent, blue				3342540825437
	M060CA02	17 cm	113 g		DJINN bent, blue				3342540825451

	Reference	Sling length	Weight	Carabiner		Sling strength	Made in	Case quantity	EAN code
				upper	lower				
Quickdraws									
Pack of 6 DJINN AXESS quickdraws Pack of six durable quickdraws for rock climbing  x 6	M060DA00	12 cm	107 g	DJINN straight	DJINN bent	22 kN	FR	3	3342540825468

	Reference	Length	Weight	Sling strength	Made in	Case quantity	EAN code
Quickdraw slings and accessories							
FINESSE Ultra-light quickdraw sling with STRING 	C042AA00	10 cm	7 g	22 kN	MY	150	3342540825710
	C042AA01	17 cm	10 g				3342540825727
EXPRESS Ergonomic quickdraw sling with STRING 	C040AA00	11 cm	15 g	22 kN	MY	150	3342540825826
	C040AA01	17 cm	22 g				100
	C040AA02	25 cm	25 g			3342540825857	
AXESS Durable quickdraw sling with STRING 	C041AA00	12 cm	16 g	22 kN	MY	150	3342540825734
	C041AA01	17 cm	22 g			100	3342540825741
STRING Quickdraw sling protector that also maintains the orientation of the carabiner (pack of 10)  x 10	M090AA00	L	2 g	-	FR	25	3342540825987





Ice axes for each activity

	Version	Ski touring	Glacier travel	Classic mountaineering	Steep skiing	Technical mountaineering	Ice climbing	Dry tooling
RIDE	adze	★★★	★		★★			
GLACIER	adze	★	★★★★	★				
GLACIER LITERIDE	adze	★★★★	★		★			
SUMMIT®	adze		★★	★★★★				
SUMMIT® EVO	adze		★★	★★★★		★		
SUM'TEC ⁽¹⁾	adze or hammer	★		★★	★★	★★★★	★	
GULLY	adze or hammer	★★		★	★★★★	★★		
QUARK ⁽¹⁾	adze or hammer			★	★★	★★★★	★★	
NOMIC ⁽¹⁾	mini hammer					★★	★★★★	★★
ERGONOMIC ⁽¹⁾	mini hammer					★	★★★★	★★★★

★★★★ Ideal use

★★ Suitable use

★ Possible use

⁽¹⁾ Ice axe with modular head

Accessories available for all Petzl ice axes



PICK AND SPIKE PROTECTION

Protector caps for ice axe pick and spike



TRIGREST

Adjustable handrest (except SUMMIT® EVO)

Ice axe/accessory compatibility for technical mountaineering, ice climbing and dry tooling

	ICE	PUR'ICE	DRY	PUR'DRY	PANNE	MARTEAU	MINI MARTEAU	MASSELOTTE	TRIGREST	GRIPREST NOMIC	GRIPREST ERGONOMIC	V-LINK
SUM'TEC	●*	●	●	●	●*	●*	●	●	●*			●
GULLY								●	●*			●
QUARK	●*	●	●	●	●*	●*	●	●	●			●
NOMIC	●	●*	●	●	●	●	●*	●*	●	●*	●	●
ERGONOMIC	●	●	●*	●	●	●	●*	●*	●	●	●*	●

* Accessory included with ice axe



Ice axe use and standards

The line of Petzl ice axes is composed of different families:

- ice axes for glacier travel and ski mountaineering
- classic mountaineering ice axes
- technical mountaineering ice axes
- ice axes for ice climbing and dry tooling

Each one of these ice axes has characteristics specific to its use on the terrain: length, shape of the shaft, of the pick...

The standards approach

In terms of standards, ice axes are divided into two types: type 1 and type 2. These types make a distinction between basic and technical ice axes.

This distinction is made using different tests:

- shaft center-load pull test
- shaft insertion strength test
- pick levering test

These tests are detailed in the diagrams here.

Type 1 ice axes

These ice axes have a lower strength requirement than Type 2 ice axes. They are generally used for skiing, glacier travel and classic mountaineering. For Type 1 ice axes, no marking is required, but if there is any, the marking is: B.

Type 2 ice axes

These ice axes have the highest strength required by the standard. They are primarily used for technical mountaineering, ice climbing and dry tooling. For Type 2 ice axes, marking is required. The marking is: T.

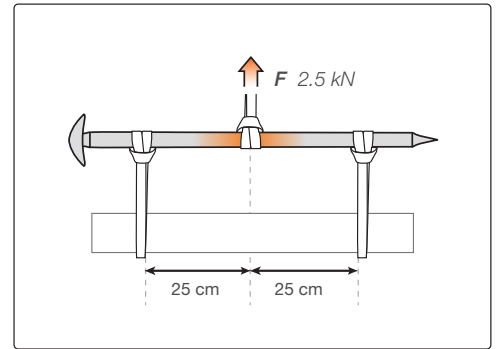



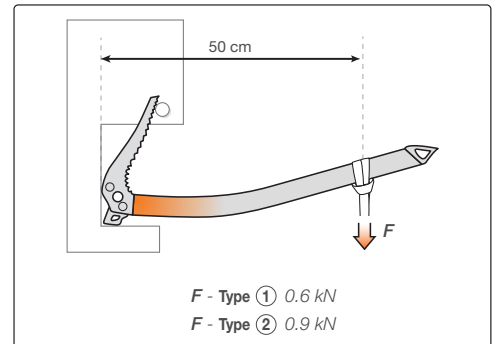



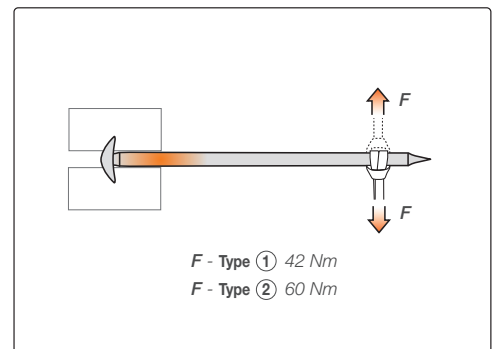



Pull test















Shaft insertion strength test







Levering test

		Reference	Version	Weight	Pick type	Shaft type	Made in	Case quantity	EAN code
Ice axes for glacier travel and ski mountaineering									
RIDE Compact, ultra-lightweight ice axe for ski touring and freeriding		U04A 45	45 cm	240 g	1	1	FR	5	3342540106314
GLACIER Lightweight performance ice axe for glacier travel		U01B 060	60 cm	350 g	1	1	FR	5	3342540100589
		U01B 068	68 cm	370 g					3342540100602
		U01B 075	75 cm	390 g					3342540100619
GLACIER LITERIDE Lightweight ice axe for glacier skiing		U01B 050	50 cm	320 g	1	1	FR	5	3342540100596
Classic mountaineering ice axes									
SUMMIT® Classic mountaineering ice axe		U13B 052	52 cm	360 g	1	1	FR	5	3342540100626
		U13B 059	59 cm	380 g					3342540100633
		U13B 066	66 cm	400 g					3342540100640
SUMMIT® EVO Technical performance ice axe for classic mountaineering		U14B 052	52 cm	400 g	1	1	FR	5	3342540100657
		U14B 059	59 cm	420 g					3342540100664
		U14B 066	66 cm	450 g					3342540100671
Technical mountaineering ice axes									
SUM' TEC Modular ice axe for technical mountaineering		U015AA00	55 cm adze	470 g	2	2	FR	5	3342540818965
		U015BA00	55 cm hammer						3342540818958
GULLY Ultra-lightweight ice axe for technical mountaineering and steep skiing		U014AA00	45 cm adze	280 g	1	1	FR	5	3342540818941
		U014BA00	45 cm hammer						3342540818934
QUARK Versatile ice axe for technical mountaineering and ice climbing		U019AA00	50 cm adze	550 g	2	2	FR	5	3342540823617
		U019BA00	50 cm hammer						3342540823624
Axes for ice climbing and dry tooling									
NOMIC Ice climbing axe		U021AA00	-	585 g	1	2	FR	5	3342540823631
ERGONOMIC High-end ice climbing and dry tooling axes		U022AA00	-	635 g	2	2	FR	5	3342540823648



		Reference	Weight	Pick type	Made in	Case quantity	EAN code
Ice axe accessories							
ICE Pick for ice and mixed climbing, designed for ice axes with modular heads		U19 ICE	129 g	2	FR	10	3342540088900
PUR'ICE Pick designed specifically for ice climbing, intended for ice axes with modular heads		U021CA00	105 g	1	FR	10	3342540824188
DRY Pick for dry tooling, designed for ice axes with modular heads		U19 DRY	129 g	2	FR	10	3342540088917
PUR'DRY Pick exclusively designed for dry tooling, for NOMIC and ERGONOMIC ice axes		U022BA00	140 g	2	FR	10	3342540824126
MINI MARTEAU Ultra-light hammer for ice axes with modular head		U021BA00	20 g	-	ES	10	3342540824201
MARTEAU Hammer for ice axes with modular head		U19 MAR	58 g	-	ES	10	3342540088931
PANNE Adze for ice axes with modular head		U19 PAN	69 g	-	ES	10	3342540088924
TRIGREST Adjustable handrest for classic and technical mountaineering ice axes		U016AA00	15 g	-	FR	10	3342540819061
GRIPREST NOMIC Handrest for NOMIC ice axe		U021DA00	40 g	-	FR	10	3342540824218
GRIPREST ERGONOMIC Handrest for ERGONOMIC ice axe		U022CA00	35 g	-	FR	10	3342540824195
CLIPPER Quick attach leash for ice climbing		U80000	62 g	-	FR	10	3342540055292
FREELock Fixed leash for technical ice axe		U81000	40 g	-	RO	10	3342540055353

	Reference	Weight	Pick type	Made in	Case quantity	EAN code
Ice axe accessories						
V-LINK Elasticated loss-prevention webbing for technical ice axes 	U083AA00	80 g	-	TW	125	3342540817470
LINKIN Removable leash for mountaineering ice axe 	U82002	25 g	-	CN	15	3342540100688
MASSELOTTES Weights for technical mountaineering, ice climbing and dry tooling ice axes 	U021EA00	65 g	-	ES	10	3342540824119
PICK AND SPIKE PROTECTION Protector caps for ice axe pick and spike 	U82003	13 g	-	CN	15	3342540100695



KIT



CLASSIC

ACTIVE

PERFORMANCE

SPECIALIZED



Mathieu Maynadier on a ski touring session, Temnevoll, Norway © 2020 - Petzl Distribution - Mathis Dumas

Petzl crampons are designed for moving over different types of terrain. Of course each one is specialized. Their versatility allows them to have complementary uses, inevitably encountered during mountaineering trips.

Crampons for each activity

	Ski touring	Snow travel	Glacier travel	Classic mountaineering	Technical mountaineering	Ice climbing	Dry tooling
LEOPARD FL		★★★					
LEOPARD LLF	★★★	★★★					
IRVIS® HYBRID	★★★	★★	★★	★			
IRVIS®	★★	★★	★★★★	★			
VASAK®	★	★★	★★★★	★★★★	★		
SARKEN		★	★★	★★	★★★★	★	
LYNX®					★★★★	★★★★	★★
DART					★★	★★★★	★★★★
D-LYNX						★	★★★★

★★★ Ideal use

★★ Suitable use

★ Possible use

Binding/crampon availability

	LEOPARD FL	LEOPARD LLF	IRVIS® HYBRID	IRVIS®	VASAK®	SARKEN	LYNX®	DART	D-LYNX
FLEXLOCK	•			•	•				screws directly onto boots
LEVERLOCK FIL		•					•		
LEVERLOCK UNIVERSEL			•	•	•	•	•		

Binding/boot compatibility

FLEXLOCK	✓	✓	✓	⚠
LEVERLOCK FIL	✗	✗	✓	✓
LEVERLOCK UNIVERSEL	FIL FLEX ✗	✓	✓	⚠
	FIL ✗	✗	✓	✓



Compatible



Gear incompatibility



Exposure to potential risk of accident or injury













Crampons

	Reference	Binding system	Weight	Number of points	Boot sizes	Made in	Case quantity	EAN code
Crampons for glacier travel and ski mountaineering								
LEOPARD LLF Ultra-lightweight crampon with LEVERLOCK FIL binding, for ski touring and snow travel 	T01A LLF	LEVERLOCK FIL	320 g	10	36 - 46	FR	6	3342540105485
	T01A FL	FLEXLOCK	384 g	10	36 - 46	FR	6	3342540105492
IRVIS® HYBRID Hybrid crampons, with steel front piece and aluminum heel piece, for approaches and glacier skiing, with LEVERLOCK UNIVERSEL binding 	T02A LLU	LEVERLOCK UNIVERSEL	540 g (FIL) 570 g (FIL FLEX)	10	36 - 46	FR	6	3342540106208
	T03A LLU	LEVERLOCK UNIVERSEL	736 g (FIL) 766 g (FIL FLEX)	10	36 - 45	FR	6	3342540104341
IRVIS® 10-point crampons for ski touring and glacier travel 	T03A FL	FLEXLOCK	790 g					3342540104358
	Classic mountaineering crampons							
VASAK® Classic mountaineering crampons with LEVERLOCK UNIVERSEL or FLEXLOCK bindings 	T05A LLU	LEVERLOCK UNIVERSEL	842 g (FIL) 872 g (FIL FLEX)	12	36 - 50	FR	6	3342540104372
	T05A FL	FLEXLOCK	892 g					3342540104365
Technical mountaineering crampons								
SARKEN Technical mountaineering crampons, with LEVERLOCK UNIVERSEL bindings 	T10A LLU	LEVERLOCK UNIVERSEL	872 g (FIL) 902 g (FIL FLEX)	12	36 - 50	FR	6	3342540104334
	Crampons for ice climbing and dry tooling							
LYNX® Modular crampon for ice and mixed climbing, with LEVERLOCK UNIVERSEL bindings 	T24A LLU	LEVERLOCK UNIVERSEL	1020 g (with ANTISNOW)	14	- 35 to 45 with M linking bar (included) - 40 to 50 with L linking bar (optional)	FR	6	3342540104402
	DART Modular crampons for ice climbing and dry tooling, with LEVERLOCK FIL bindings 	U001AA00	LEVERLOCK FIL	820 g	12	- 34 to 44 with M linking bar (included) - 38 to 49 with L linking bar (optional)	FR	6
D-LYNX Screw-in mono-point crampons for ice climbing, mixed climbing and dry tooling 		T25	-	400 g	9	-	FR	4

		Reference	Weight	Compatibility	Made in	Case quantity	EAN code
Crampon accessories							
IRVIS® front sections IRVIS crampon front sections, adaptable to all Petzl crampons		T03A AV	275 g	LEOPARD FL, LEOPARD LLF, IRVIS HYBRID, IRVIS, VASAK, SARKEN, LYNX, DART	FR	12	3342540104563
VASAK® front sections VASAK crampon front sections, adaptable to all Petzl crampons		T05A AV	375 g	IRVIS HYBRID, IRVIS, VASAK, SARKEN, LYNX, DART	FR	12	3342540104549
SARKEN crampon front sections SARKEN crampon front sections, adaptable to all Petzl crampons		T10A AV	405 g	IRVIS HYBRID, IRVIS, VASAK, SARKEN, LYNX, DART	FR	12	3342540104532
DART crampon front sections DART crampon front sections, adaptable to all Petzl crampons		U001EA00	415 g	LEOPARD FL, LEOPARD LLF, IRVIS HYBRID, IRVIS, VASAK, SARKEN, LYNX, DART	FR	12	3342540828612
LYNX® front point kit		T24850	150 g	LYNX, DART	FR	10	3342540092235
KIT CORD-TEC Ultra-light rear sections, compatible with IRVIS and DART crampons		U001GA00	120 g	LEOPARD, IRVIS HYBRID, IRVIS, DART	FR	12	3342540828636
FIL FLEX Toe bails allow boots without welts to be used with technical mountaineering crampons		T03A FF	70 g	LEOPARD, IRVIS, VASAK, SARKEN, LYNX, DART	FR	10	3342540104556
BACK FLEX Heel bails allow any type of Petzl crampon to be used with boots without heel welts		T03A BFL	120 g	LEOPARD FL, LEOPARD LLF, IRVIS HYBRID, IRVIS, VASAK, SARKEN, LYNX, DART	FR	10	3342540818217
FIL Toe bails allow any type of Petzl crampon to be used with boots with toe welts		T03A FIL	30 g	LEOPARD FL, LEOPARD LLF, IRVIS HYBRID, IRVIS, VASAK, SARKEN, LYNX, DART	FR	10	3342540818125
FIL SMALL Toe bails that allow any type of Petzl crampon to be used with narrow boots with toe welts		U001FA00	30 g	LEOPARD FL, LEOPARD LLF, IRVIS HYBRID, IRVIS, VASAK, SARKEN, LYNX, DART	FR	10	3342540828629
FIL TELEMARCK Toe bails that allow any type of Petzl crampon to be used with telemark boots		T03600	30 g	LEOPARD FL, LEOPARD LLF, IRVIS HYBRID, IRVIS, VASAK, SARKEN, LYNX, DART	FR	10	3342540065291
ELASTIC STRAP Elastic straps designed for the LEVERLOCK FIL binding system		U001CA00	30 g	BACK LEVER	CN	10	3342540824461
BACK LEVER Heel bails, allowing any type of Petzl crampon to be used on boots with heel welts		U001BA00	100 g	LEOPARD FL, LEOPARD LLF, IRVIS HYBRID, IRVIS, VASAK, SARKEN, LYNX, DART	FR	10	3342540824454



Crampons

	Reference	Weight	Compatibility	Made in	Case quantity	EAN code
2 reversible linking bars L 	T20850	-	IRVIS, VASAK, SARKEN, LYNX, DART	FR	10	3342540055711
BARRETTE Replacement linking bars for IRVIS, VASAK and SARKEN crampons 	T03A BA	110 g	IRVIS, VASAK, SARKEN	FR	10	3342540104525
FLEX Linking bars that make the connection between the front and rear Petzl crampon sections more flexible for use with flexible and/or larger sized shoes 	T03A BS	70 g	IRVIS, VASAK, SARKEN, LYNX, DART	FR	10	3342540104518
ANTISNOW System included with crampons that limits snow buildup under the crampons in any snow conditions 	T03A AS	-	IRVIS	FR	10	3342540104587
	T05A AS		VASAK, SARKEN			3342540104570
ANTISNOW LEOPARD System suitable for LEOPARD FL and LEOPARD LLF crampons. It limits snow buildup under the crampons in any snow conditions 	T01A AS	-	LEOPARD FL, LEOPARD LLF	FR	10	3342540106338
ANTISNOW for LYNX® System compatible with LYNX crampons. It limits snow buildup under the crampons in any snow conditions 	T24960	-	LYNX	FR	10	3342540092266
ANTISNOW DART System compatible with DART crampons. It limits snow buildup under the crampons in any snow conditions 	U001DA00	-	DART	FR	10	3342540828605
CORD-TEC replacement cord Replacement cord for the flexible linking system on LEOPARD LLF, LEOPARD FL, IRVIS HYBRID and KIT CORD-TEC crampons  x 2	T01A COR	-	LEOPARD FL, LEOPARD LLF, IRVIS HYBRID	FR	10	3342540106321
FAKIR pouch Durable crampon pouch 	V01	140 g	LEOPARD FL, LEOPARD LLF, IRVIS HYBRID, IRVIS, VASAK, SARKEN, LYNX, DART	CN	15	3342540063341
CORD-TEC pouch Ultra-light, compact pouch for CORD-TEC equipped crampons 	U003BA00	30 g	LEOPARD FL, LEOPARD LLF, IRVIS HYBRID	TN	10	3342540828728
ULTRALIGHT pouch Ultra-lightweight pouch for crampons 	U003AA00	50 g	LEOPARD FL, LEOPARD LLF, IRVIS HYBRID, IRVIS, VASAK, SARKEN, LYNX, DART	TN	32	3342540828667

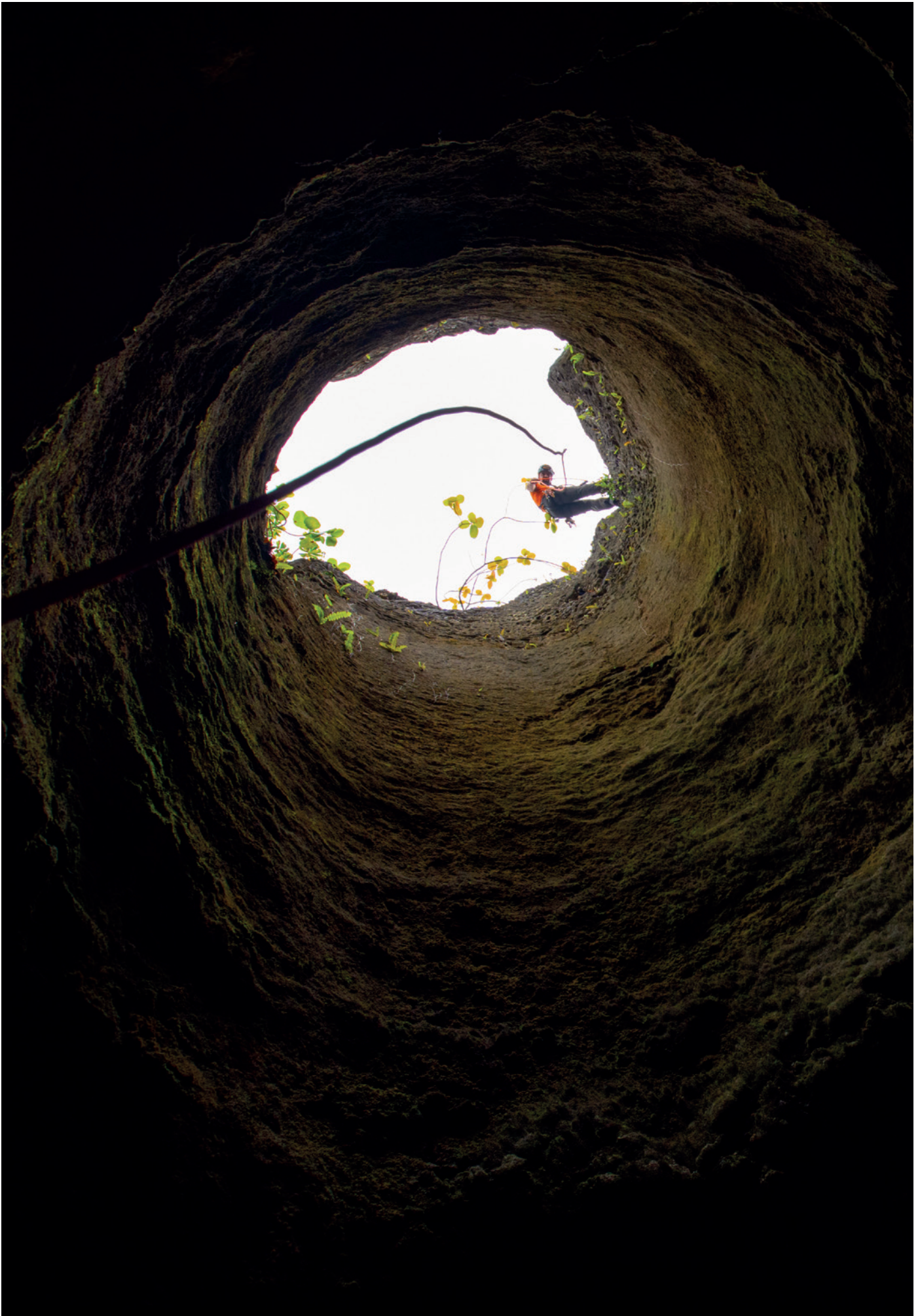

Oliver Testa caving in Makatea, Polynesia © 2019 - Petzl Distribution - Guillaume Broust

-
-
-
-
-
-
-
-
- KIT**
-
-
- CLASSIC**
-
- ACTIVE**
-
- PERFORMANCE**
-
- SPECIALIZED**
-

Ascenders

Petzl ascenders are designed for ascending fixed ropes, but they also have other uses: helping a second in difficulty, hauling a victim out of a crevasse or up a wall, self-belaying... For this, there are several types of ascenders: hand ascenders, chest ascenders and backup ascenders.

Types of Petzl ascenders

Hand ascenders

Because of their excellent handling, these ascenders are mainly used for ascending ropes. Their design also provides various ways to install the device on a rope to make a pulley system or haul a pack.



ASCENSION

Handled ascender with a comfortable, powerful grip



BASIC

Compact and lightweight ascender

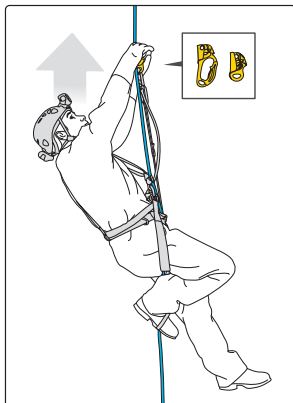

Rope ascent with hand ascender installed above the user

Examples of other ways to use hand ascenders

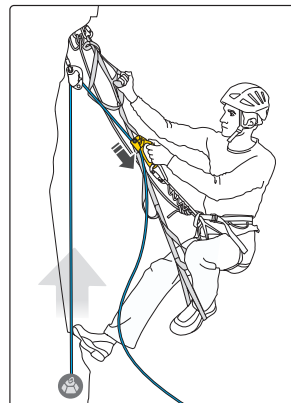

Hauling with an ASCENSION handled ascender

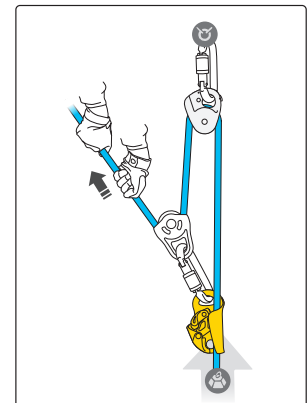

Pulley system with a BASIC ascender

Chest ascenders

Installed directly to the harness, they are used with a hand ascender for ascending a rope.



CROLL® S

Reinforced chest ascender for thin to medium-diameter ropes



CROLL® L

Chest ascender for large-diameter ropes

Backup ascender



TIBLOC

Ultralight and compact, TIBLOC is a backup ascender that adapts readily to situations other than ascending ropes: pulley systems, progress capture...

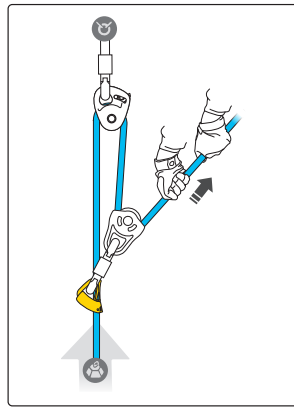

Hauling gear

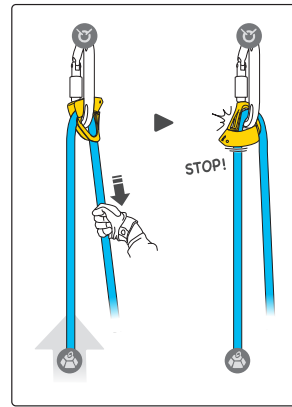

Hauling a person

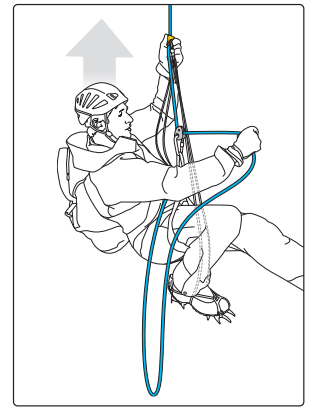

Ascending a rope

Ascender accessories

For greater efficiency and convenience when ascending, Petzl offers accessories for use with hand and chest ascenders.



PANTIN

Foot ascender



FOOTAPE

Adjustable webbing foot loop



FOOTCORD

Adjustable foot loop made with HDPE cord for greater versatility and optimal durability

Locking systems



Locking with toothed cam (all ascenders except TIBLOC)





The teeth initiate the locking action, and the cam pinches the rope. Locking is optimal in all conditions: wet, frozen, muddy rope..., while sliding the device upward is easy.



Locking with teeth and carabiner (TIBLOC)

The carabiner locks the rope by pinching it against the teeth. The self-cleaning slot enables use under any conditions: wet, icy, or muddy rope... Locking with teeth and carabiner provides an ultra-light solution.

Choosing your ascender

	 ASCENSION	 BASIC	 CROLL® S	 CROLL® L	 TIBLOC
Ascender type	hand		chest		backup
Locking system	toothed cam				carabiner/teeth
Ideal use	rope ascent, hauling	rope ascent, pulley system	rope ascent, with a hand ascender		rope ascent, haul system, progress capture
Rope compatibility	8 to 13 mm	8 to 11 mm	8 to 11 mm	8 to 13 mm	8 to 11 mm
Weight	165 g	85 g	85 g	140 g	35 g



		Reference	Version	Weight	Rope diameter	Made in	Case quantity	EAN code
Ascenders								
ASCENSION Ergonomic handled ascender		B17ALA	left-handed (black)	165 g	8 to 13 mm	FR	10	3342540100411
		B17ARA	right-handed (yellow)					3342540100404
CROLL® S Reinforced chest ascender for thin to medium-diameter ropes		B16BAA	-	85 g	8 to 11 mm	FR	12	3342540094307
CROLL® L Chest ascender for large-diameter ropes		B016AA00	-	140 g	8 to 13 mm	FR	16	3342540821057
PANTIN® Foot ascender		B02CLA	left (black)	85 g	8 to 13 mm	FR	8	3342540103771
		B02CRA	right (yellow)					3342540103764
Multipurpose ascenders								
BASIC Compact, versatile ascender		B18BAA	-	85 g	8 to 11 mm	FR	10	3342540094314
TIBLOC Ultra-lightweight emergency ascender		B01B	-	35 g	8 to 11 mm	FR	8	3342540101418
Ascender accessories								
FOOTAPE Adjustable webbing foot loop		C47A	-	65 g	-	FR	8	3342540095229
FOOTCORD Adjustable cord foot loop		C48A	-	40 g	-	FR	10	3342540095236



Via ferrata in Florac, France © 2019 Petzl Distribution - Sam Bié



CLASSIC

ACTIVE

PERFORMANCE

SPECIALIZED

KIT

		Reference	Weight	Rope diameter	Efficiency	Made in	Case quantity	EAN code
Progress-capture pulleys								
PRO TRAXION Efficient drop-resistant progress-capture pulley		P51 A	265 g	8 to 13 mm	95 %	FR	8	3342540096059
MICRO TRAXION High-efficiency lightweight progress-capture pulley		P53	85 g	8 to 11 mm	91 %	FR	18	3342540091986
NANO TRAXION High-efficiency, ultra-lightweight progress-capture pulley		P053AA00	53 g	7 to 11 mm	91 %	FR	18	20
Crevasse rescue kit								
CREVASSE RESCUE KIT Kit for hauling and self-rescue from crevasses		K025AA00	370 g	8 to 11 mm	-	FR	4	3342540829374
Single pulleys								
PARTNER Compact pulley with swinging side plates		P52A	56 g	7 to 11 mm	91 %	FR	12	3342540087811
RESCUE High-strength pulley with swinging side plates		P50A	185 g	7 to 13 mm	95 %	FR	10	3342540087798
FIXE Pulley with fixed side plates		P05SO	90 g	7 to 13 mm	71 %	FR	12	3342540087347
OSCILLANTE Emergency pulley with swinging side plates		P02A	42 g	7 to 11 mm	71 %	FR	24	3342540087330
ULTRALEGERE Emergency pulley		P00A	10 g	7 to 13 mm	-	FR	30	3342540087354
Prusik pulleys								
MINI Lightweight Prusik pulley		P59A	80 g	7 to 11 mm	91 %	FR	10	3342540087729
GEMINI Double Prusik pulley		P66A	135 g	7 to 11 mm	91 %	FR	8	3342540087743
Transport pulleys								
TANDEM® Double pulley for travel along ropes		P21	195 g	max rope: 13 mm	71 %	FR	20	3342540025929
TANDEM® SPEED Efficient double pulley for travel along ropes		P21 SPE	270 g	max rope: 13 mm	95 %	FR	20	3342540041868



Via ferrata in Florac, France © 2019 Petzl Distribution - Sam Bié

-
-
-
-
-
-
-
-
-
-
-
- KIT**
-
-
-
- CLASSIC
-
- ACTIVE
-
- PERFORMANCE
-
- SPECIALIZED
-

Lanyards

Lanyards are essential in many activities: via ferrata, caving, canyoning... Therefore, Petzl proposes lanyards, with or without energy absorbers, that respond to the specific needs of these activities.

Via ferrata lanyards

• For users weighing 40 to 120 kg



SCORPIO lanyards meet the EN 958: 2017 standard, authorizing use by those weighing between 40 and 120 kg.

Their energy absorber is composed of tear-webbing. In the event of a fall, the tearing of the energy absorber reduces the impact of the fall on the user. This tearing takes place progressively.

Concept:

- the length of tearing required for shock absorption depends on the energy generated by the fall. The latter depends on the length of the fall and the weight of the user
- the greater the energy, the longer the tearing

• Comfortable and durable



Comfortable, thanks to a short connection of the lanyard to the harness.

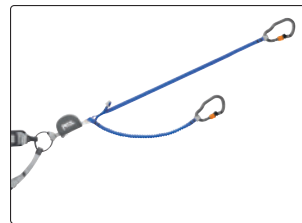

Two elasticized arms have long extension capacity to adapt to all body types. The arms are extremely durable, thanks to their construction in high-modulus polyethylene (HMPE).

• SCORPIO VERTIGO for less weight and more durability



The VERTIGO WIRE-LOCK carabiner has an auto-locking system. The WIRE-LOCK system increases the lifetime of the carabiner when used intensively.

• SCORPIO EASHOOK, for an even more comfortable experience



The EASHOOK carabiner features an auto-locking system. It offers excellent handling and adapts to all hand sizes.

The anti-twist system prevents the arms from tangling and makes progression more comfortable.

Via ferrata kits: essential for adventure



KIT VIA FERRATA VERTIGO



KIT VIA FERRATA EASHOOK

Each kit is composed of a SCORPIO VERTIGO or SCORPIO EASHOOK lanyard, a CORAX harness, and a BOREO® helmet.

Lanyards for climbing, mountaineering, caving and canyoning

Petzl offers many types of lanyards: dynamic, static, single, double, asymmetrical, adjustable...

• Lanyards for every situation

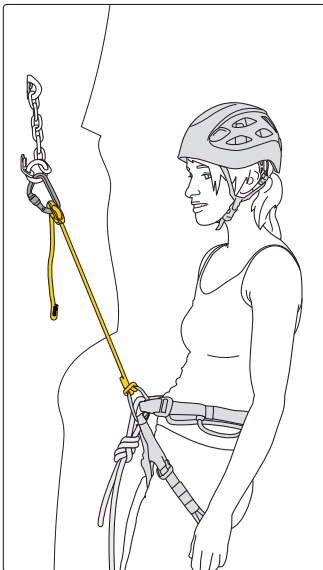

The CONNECT ADJUST single lanyard allows the user to position him/herself at an anchor.

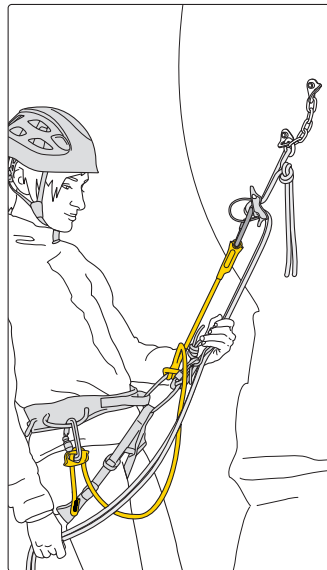

The DUAL CONNECT ADJUST and DUAL CONNECT VARIO double lanyards allows the user to tether him/herself in order to set up a rappel system when climbing or mountaineering.

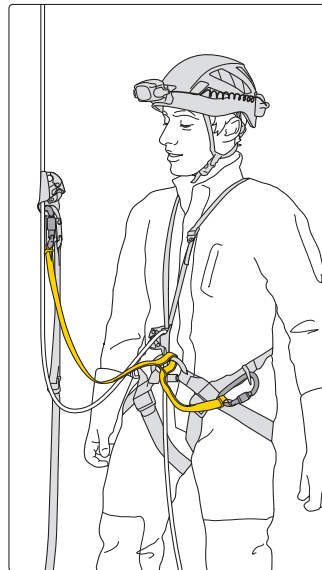

The asymmetrical SPELEGYCA double lanyard allows for different manipulations when caving: tethering oneself, passing intermediate anchors or ascending a rope.

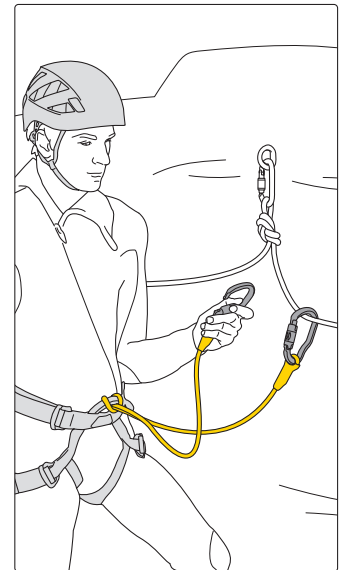

The DUAL CANYON CLUB, DUAL CANYON GUIDE and DUAL CONNECT VARIO lanyards allow positioning at the anchor and progression along a lifeline when canyoning.

• Length is adjustable, thanks to the ADJUST rope adjuster



Lanyards equipped with the ADJUST rope adjuster can have the length of the adjustable arm quickly and precisely modified. This adjustment option allows optimal positioning during maneuvers at the anchor.

• Versatility with the DUAL CONNECT VARIO lanyard













This lanyard may be used for tethering oneself, or for installing a rappel system or an equalized belay station.

Choosing your lanyard

	CONNECT ADJUST	DUAL CONNECT ADJUST	DUAL CONNECT VARIO	SPELEGYCA	DUAL CANYON CLUB	DUAL CANYON GUIDE
Activity	climbing and mountaineering		climbing, mountaineering and canyoning	caving	canyoning	
Lanyard type	single	double		double	double	
Dynamic rope		•		-	•	
Setup	girth hitch		girth hitch or figure eight knot	semi-circle or quick link	girth hitch	metal D or quick link
Adjustable		•	•	-	-	•
Length	15-95 cm	45 cm / 15-95 cm	180 cm max	32 cm / 58 cm	65 cm	65 cm / 15-80 cm



	Reference	Weight	Specifics	Made in	Case quantity	EAN code
Via ferrata lanyards						
SCORPIO EASHOOK Via ferrata lanyard with EASHOOK carabiners and anti-twist system, for users weighing 40 to 120 kg 	L060BA00	470 g	- retracted length: 84.5 cm - short arm length: 36 cm	TW	10	3342540819078
KIT VIA FERRATA EASHOOK Via ferrata kit includes a SCORPIO EASHOOK lanyard, a CORAX harness, and a BOREO helmet 	K029DA00	1235 g	- harness: size 1 / 65 - 96 cm - helmet: size M/L / 53 - 61 cm	-	4	3342540834774
	K029DA01	1285 g	- harness: size 2 / 76 - 107 cm - helmet: size M/L / 53 - 61 cm			3342540834781
SCORPIO VERTIGO Via ferrata lanyard with VERTIGO WIRE-LOCK carabiners, for users weighing 40 to 120 kg 	L060AA00	380 g	- retracted length: 77 cm - short arm length: 32 cm	CN	10	3342540819085
KIT VIA FERRATA VERTIGO Via ferrata kit includes a SCORPIO VERTIGO lanyard, a CORAX harness, and a BOREO helmet 	K029CA00	1145 g	- harness: size 1 / 65 - 96 cm - helmet: size M/L / 53 - 61 cm	-	4	3342540834750
	K029CA01	1195 g	- harness: size 2 / 76 - 107 cm - helmet: size M/L / 53 - 61 cm			3342540834767
Climbing and mountaineering lanyards						
CONNECT ADJUST Adjustable single lanyard for climbing and mountaineering 	L034AA00	125 g	length: 15 - 95 cm	-	20	3342540835467
DUAL CONNECT ADJUST Adjustable double lanyard for climbing and mountaineering 	L035BA00	160 g	- fixed arm length: 45 cm - adjustable arm length: 15 to 95 cm	-	20	3342540835474
DUAL CONNECT VARIO Completely adjustable double lanyard and anchor system for climbing and mountaineering 	L087AA00	180 g	length: 180 cm	TW	20	3342540832985
Caving lanyard						
SPELEGYCA Asymmetric double lanyard for caving 	L002AA00	90 g	strength: 22 kN	FR	15	3342540829756
Canyoning lanyards						
DUAL CANYON CLUB Double lanyard for canyoning 	L086AB00	130 g	- length: 65 cm	-	20	3342540835610
DUAL CANYON GUIDE Adjustable double lanyard for canyoning 	L086BB00	175 g	- fixed arm length: 65 cm - adjustable arm length: 15 to 80 cm	-	20	3342540835627



Via ferrata in Florac, France © 2019 Petzl Distribution - Sam Bié



KIT



CLASSIC









ACTIVE



PERFORMANCE



SPECIALIZED

	Reference	Weight		Made in	Case quantity	EAN code
Climbing kits						
KIT CORAX GRIGRI Sm'D NEW 2021 Climbing kit containing CORAX harness, GRIGRI assisted blocking belay device, and Sm'D carabiner 	K032AA00	700 g	- gray harness: size 1 / 65 - 96 cm	MY	4	3342540835658
	K032AA01	750 g	- gray harness: size 2 / 76 - 107 cm			3342540835665
KIT CORAX YSI Sm'D NEW 2021 Climbing kit containing CORAX harness, YSI assisted braking belay device, and Sm'D carabiner 	K031AA00	640 g	- gray harness: size 1 / 65 - 96 cm	MY	4	3342540835634
	K031AA01	690 g	- gray harness: size 2 / 76 - 107 cm			3342540835641
Via ferrata kits						
KIT VIA FERRATA EASHOOK NEW 2021 Via ferrata kit includes a SCORPIO EASHOOK lanyard, a CORAX harness, and a BOREO helmet 	K029DA00	1235 g	- gray harness: size 1 / 65 - 96 cm - helmet: size M/L / 53 - 61 cm	-	4	3342540834774
	K029DA01	1285 g	- gray harness: size 2 / 76 - 107 cm - helmet: size M/L / 53 - 61 cm			3342540834781
KIT VIA FERRATA VERTIGO NEW 2021 Via ferrata kit includes a SCORPIO VERTIGO lanyard, a CORAX harness, and a BOREO helmet 	K029CA00	1145 g	- gray harness: size 1 / 65 - 96 cm - helmet: size M/L / 53 - 61 cm	-	4	3342540834750
	K029CA01	1195 g	- gray harness: size 2 / 76 - 107 cm - helmet: size M/L / 53 - 61 cm			3342540834767
Rescue kits						
RAD SYSTEM A complete ultra-lightweight and compact kit with special cord, designed for skiers for crevasse rescue, rappelling, or roping up on a glacier to get out of a crevasse zone 	K011AA00	1000 g	Cord length: 30 m	CZ	3	3342540832626
CREVASSE RESCUE KIT Kit for hauling and self-rescue from crevasses 	K025AA00	370 g	- Rope diameter: 8 to 11 mm	FR	4	3342540829374









Ice climbing with Tanja & Heike Schmitt and Matthias Scherer on the Storstampen pillar icefall in Norway. © 2020 - Petzl Distribution - Mathis Dumas















KIT





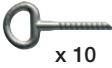



SPECIALIZED





		Reference	Length	Weight	Made in	Case quantity	EAN code
Ice anchors							
LASER SPEED LIGHT Ultra-lightweight ice screw with integrated crank 	G052AA00	13 cm	91 g	FR	12	3342540832701	
	G052AA01	17 cm	100 g			3342540832718	
	G052AA02	21 cm	110 g			3342540832725	
LASER SPEED Ultra-high-performance ice screw with integrated crank 	G051AA00	13 cm	128 g	FR	12	3342540832664	
	G051AA01	17 cm	143 g			3342540832671	
	G051AA02	21 cm	161 g			3342540832688	
LASER SPEED 10 cm Ultra-high-performance progression ice screw, with integrated crank 	G051AA03	10 cm	113 g	FR	12	3342540832695	
						<i>Not available in France</i>	
LASER Lightweight, high-performance ice screw 	G050AA00	13 cm	120 g	FR	12	3342540832633	
	G050AA01	17 cm	135 g			3342540832640	
	G050AA02	21 cm	153 g			3342540832657	
Ice protection accessories							
LIM'ICE Sharpener for ice screws 	V70	-	162 g	FR	6	3342540095939	
MULTIHOOK Multi-function, foldable threading tool 	U002AA00	28 cm	40 g	FR	20	3342540828650	
OCTO Protective carrying pouch for ice screws 	U010AA00	-	160 g	CN	50	3342540828643	









		Reference	Diameter	Drilling depth	Weight	Made in	Case quantity	EAN code
Rock anchors								
COEUR BOLT STEEL Steel anchor for interior uses (pack of 20)  x 20	P36BA 10	10 mm	8.5 cm	110 g	FR	1	3342540104198	
	P36BA 12	12 mm	9.5 cm	135 g			3342540104136	
COEUR STEEL Steel hanger for interior uses (pack of 20)  x 20	P36AA 10	10 mm	-	65 g	FR	4	3342540104174	
	P36AA 12	12 mm	-	60 g			3342540104150	
COEUR BOLT STAINLESS Stainless steel anchor for typical exterior uses (pack of 20)  x 20	P36BS 10	10 mm	7 cm	110 g	DE	1	3342540104181	
	P36BS 12	12 mm	8.5 cm	135 g			3342540104129	
COEUR STAINLESS Stainless steel hanger for typical exterior uses (pack of 20)  x 20	P36AS 10	10 mm	-	65 g	FR	4	3342540104167	
	P36AS 12	12 mm	-	60 g			3342540104143	
COEUR BOLT HCR High Corrosion Resistance stainless steel anchor for corrosive environments (pack of 20)  x 20	P36BH 12	12 mm	8.5 cm	135 g	DE	1	3342540104105	
COEUR HCR High Corrosion Resistance stainless steel hanger for corrosive environments (pack of 20)  x 20	P36AH 12	12 mm	-	60 g	FR	4	3342540104112	



		Reference	Diameter	Drilling depth	Weight	Made in	Case quantity	EAN code
COEUR PULSE Removable 12 mm anchor with locking function		P37S 12	12 mm	6.5 cm	140 g	FR	8	3342540815889
PULSE Temporary 8 mm anchor for caving		P37S 8	8 mm	5 cm	45 g	FR	8	3342540818446
BAT'INOX 14 mm resin anchor (pack of 10)	 x 10	G102AA00	14 mm	10 cm	250 g	FR	2	3342540829824
AMPOULE BAT'INOX Resin glue for BAT'INOX (pack of 10)	 x 10	G103AA00	-	-	20 g	NL	9	3342540829862
COLLINOX 10 mm resin anchor (pack of 10)	 x 10	G100AA00	10 mm	7 cm	95 g	FR	2	3342540829817
AMPOULE COLLINOX Resin glue for COLLINOX (pack of 10)	 x 10	G101AA00	-	-	14 g	NL	14	3342540829855

		Reference	Length	Weight	Made in	Case quantity	EAN code
Pitons							
V CONIQUE Chromoly steel knifeblade piton		66007	7 cm	-	FR	10	3342540660076
		66011	11 cm	95 g			3342540660113
UNIVERSEL Semi-hardened steel forged piton		P17 5	5 cm	-	FR	10	3342540089716
		P17 7	7 cm	95 g			3342540089723
		P17 9	9 cm	-			3342540089730
ROCHER MIXTE Semi-hardened steel forged piton		65106	6 cm	-	FR	10	3342540651067
		65108	8 cm	90 g			3342540651081
		65110	10 cm	-			3342540651104
U Semi-hardened steel forged piton		65312	10 cm	125 g	FR	10	3342540653122
		65314	12 cm	-			3342540653146
LIVANOS Chromoly steel knifeblade piton		65504	4 cm	-	FR	10	3342540655041
		65506	6 cm	-			3342540655065
		65508	8 cm	48 g			3342540655089
		65510	10 cm	-			3342540655102
Rock and caving anchors							
VRILLEE Caving bolt hanger (pack of 25)	 x 25	G104AA00	-	32 g	FR	2	3342540829831
COUDEE Caving bolt hanger (pack of 25)	 x 25	G105AA00	-	32 g	FR	2	3342540829848



		Reference	Unit weight	Major axis strength	Minor axis strength	Made in	Case quantity	EAN code
Quick links								
DELTA Triangular quick link		P11	150 g	25 kN	10 kN	FR	30	3342540008649
SPEEDY Quick link with rapid gate (pack of 5)	 x 5	G106AA00	23 g	15 kN	-	FR	20	3342540829879
GO 8 mm 8 mm wide-opening, galvanized steel quick link	 x10 x1	NEW 2021 P015AA00	95 g	30 kN	10 kN	FR	4	3342540833012
		P015AA01					50	3342540834996
DEMI ROND Semi-circular quick link		P18	55 g	25 kN	10 kN	FR	30	3342540008823



		Reference	Weight	Specifics	Made in	Case quantity	EAN code
Rock and caving anchor accessories							
BONGO Piton hammer		P27	680 g	length: 33 cm	FR	10	3342540070486
TAM TAM Caving hammer		P16	535 g	length: 26.5 cm	FR	10	3342540008755
ROCPEC SDS-bit hand drill		P26	198 g	-	FR	10	3342540038462
ROCPEC ADP Adapter for ROCPEC drill		P26250	37 g	-	FR	50	3342540057357
PERFO SPE Drill for self-drilling anchors		P08	208 g	diameter: 8 mm	FR	10	3342540008526
BOLTBAG Bolting gear pouch		C11 A	170 g	-	CN	15	3342540087309
PROTEC Rope protector		C45 N	95 g	-	RO	30	3342540086746
SWIVEL S Ball bearing swivel		P58 S	95 g	Breaking strength: 23 kN Working load: 5 kN	IT	10	3342540070868
PAW S Rigging plate	 NEW 2021	G063AA00	60 g	Breaking strength: 36 kN	IT	10	3342540835870

	Reference	Length	Color	Weight	Made in	Case quantity	EAN code
Sewn slings							
ANNEAU Polyester sling 	C40A 60	60 cm	yellow	60 g	MY	50	3342540103436
	C40A 80	80 cm	blue	80 g		3342540105140	
	C40A 120	120 cm	green	100 g		25	3342540103429
	C40A 150	150 cm	red	135 g		3342540105133	
ST'ANNEAU Dyneema® sling 	C07 24	24 cm	green	10 g	FR	50	3342540071773
	C07 60	60 cm	yellow	20 g		3342540071780	
	C07 120	120 cm	red	40 g		25	3342540071797
PUR'ANNEAU Very lightweight sling in high-modulus polyethylene 	G006AA00	60 cm	yellow	18 g	FR	50	3342540817555
	G006AA01	120 cm	red	32 g		25	3342540817562
	G006AA02	180 cm	violet	48 g		15	3342540817579





Bouldering during the Petzl Junior Rock Camp in Germany © 2019 - Petzl Distribution - Julian Bückers





	Reference	Unfolded dimensions	Folded dimensions	Weight	Made in	Case quantity	EAN code
Crashpads							
ALTO Crashpad for bouldering 	K02AO	118 x 100 x 10 cm	65 x 100 x 25 cm	5700 g	FR	1	3342540099746
CIRRO Maxi crashpad for bouldering 	K01AO	148 x 118 x 12.5 cm	75 x 118 x 35 cm	9400 g	FR	1	3342540098473
NIMBO Back-up pad for bouldering 	K03AO	75 x 50 x 3 cm	-	700 g	CN	4	3342540099739





Julia Chanourdie and Paul Jent climbing in Espace Vertical 3, Grenoble, France © 2019 - Petzl Distribution - Sam Blé - Espace Vertical

	Reference	Color	Weight	Made in	Case quantity	EAN code
Chalk bags						
BANDI Chalk bag with round shape 	S038BA00	gray	75 g	-	30	3342540835498
	S038BA01	turquoise				3342540835504
SAKA Chalk bag with ergonomic shape 	S039BA00	gray	80 g	-	30	3342540835511
	S039BA01	violet				3342540835030
SAKAPOCHE Ergonomically shaped chalk bag with pocket 	S040AA00	gray	85 g	CN	30	3342540819986
	S040AA01	red				3342540819993
SAKAB Bouldering chalk bag placed on the ground 	S037AA00	gray	205 g	VN	72	3342540832824
SAKOVER Ultra-lightweight sealed bag for storage and transport of chalk bags 	S036AA00	gray	40 g	VN	156	3342540832831
Chalk						
POWER CRUNCH Chunky chalk 	P22AS 100	-	100 g	CZ	80	3342540097292
	P22AS 200	-	200 g		40	3342540097285
POWER CRUNCH BOX Chunky chalk in a box 	P22AX 100	-	100 g	CZ	60	3342540097278
POWER BALL Chalk ball 	P22AB 040	-	40 g	CZ	250	3342540097261
POWER LIQUID Liquid chalk in a tube 	P22AL 200	-	200 ml	CZ	25	3342540097254

	Reference	Color	Weight	Volume	Made in	Case quantity	EAN code
Climbing packs							
BUG Pack for single-day multi-pitch climbing 	S073AA00	gray	525 g	18 liters	VN	15	3342540825994
	S073AA01	red/orange					3342540826007
KAB Rope bag for gym climbing 	S011AA00	gray	880 g	20 to 26 liters	VN	10	3342540825789
KLIFF Rope bag for rock climbing 	S010AA00	gray	750 g	36 liters	VN	10	3342540825796
	S010AA01	red/orange					3342540825802
TARP Large rope tarp 	S012AA00	black	280 g	-	-	10	3342540835153
Canyoning pack							
ALCANADRE Large volume pack for transporting canyoning gear 	S64A	yellow/black	1150 g	45 liters	CN	8	3342540104723





KIT



Packs and accessories

		Reference	Color	Weight	Volume	Made in	Case quantity	EAN code
Caving packs								
	TRANSPORT 45L Durable and comfortable large capacity pack for caving	S42Y 045	yellow/gray/black	1300 g	45 liters	CN	5	3342540090385
	PORTAGE 30L Durable medium-capacity pack for caving	S43Y 030	yellow/black	800 g	30 liters	CN	10	3342540090354
	CLASSIQUE 22L Durable medium-capacity pack for caving	C03 2	yellow/black	550 g	22 liters	CN	10	3342540087101
	PERSONNEL 15L Durable small capacity pack for caving	S44Y 015	yellow/black	450 g	15 liters	CN	15	3342540090378

		Reference	Weight	Working load limit	Made in	Case quantity	EAN code
Rescue litters							
	NEST Litter for confined spaces	S061AA00	13100 g	140 kg	FR	1	3342540829558
	STEF Tilting device for NEST litter	S059AA00	640 g	140 kg	FR	5	3342540829749
	STEF for NEST litter before 2020 Tilting device for NEST litter before 2020	S059BA00	620 g	140 kg	FR	5	3342540832244
	Bag for NEST litter	S062AA00	1860 g	-	RO	2	3342540831568



		Reference	Size	Color	Weight	Made in	Case quantity	EAN code
Gloves								
	CORDEX Lightweight belay/rappel gloves	K52 SN	S	black	105 g	VN	30	3342540080461
		K52 MN	M		115 g			3342540080478
		K52 LN	L		118 g			3342540080485
		K52 XLN	XL		120 g			3342540080492
	K52 XST	XS	tan	100 g	3342540076020			
	K52 ST	S		105 g	3342540072688			
	K52 MT	M		115 g	3342540072695			
	K52 LT	L		118 g	3342540072701			
	K52 XLT	XL		120 g	3342540072718			



		Reference	Size	Color	Weight	Made in	Case quantity	EAN code
CORDEX PLUS Belay/rappel gloves		K53 SN	S	black	136 g	VN	30	3342540080508
		K53 MN	M		140 g			3342540080515
		K53 LN	L		146 g			3342540080522
		K53 XLN	XL		152 g			3342540080539
		K53 XST	XS	tan	132 g			3342540076037
		K53 ST	S		136 g			3342540072725
		K53 MT	M		140 g			3342540072732
		K53 LT	L		146 g			3342540072749
		K53 XLT	XL		152 g			3342540072756

		Reference	Weight	Specifics	Made in	Case quantity	EAN code
Aid climbing accessories							
EVOLV ADJUST Positioning device with two adjustable arms		L35ARD	220 g	length: 15 - 150 cm	TW	16	3342540100862
SHUNT Rappel backup device		B03B	188 g	Rope compatibility: 10-11 mm single ropes or half ropes 8-11 mm	FR	14	3342540817944
FIFI Suspension hook for aid climbing		V12	38 g	-	FR	50	3342540067875
MAILLON RAPIDE N° 5 Quick link for installing a retrieval system on the FIFI hook		P49100	-	-	FR	100	3342540044081
GOUTTE D'EAU Large radius progression hook		P06 2	46 g	-	FR	30	3342540092006
REGLETTE Small radius progression hook		P06 1	38 g	-	FR	30	3342540091993
QUICKSTEP Adjustable single-step etrier for aid climbing		C09	142 g	-	FR	15	3342540054592
LOOPING Four-step etrier for aid climbing		C25	145 g	black/yellow	FR	10	3342540001299
GRADISTEP Lightweight five-step etrier for aided sections on free climbs		C08	146 g	black/gray	FR	15	3342540054585



Packs and accessories

	Reference	Weight	Specifics	Made in	Case quantity	EAN code
Other accessories						
CARNET Topographic notebook for caving 	S90	150 g	15 x 10.5 cm (A6 format)	FR	96	3342540030541
	S91	210 g	21 x 15 cm (A5 format)		55	3342540030558
SPATHA Knife with carabiner hole 	S92AY	43 g	yellow	FR	20	3342540097384
	S92AB		blue			3342540097377

	Reference	Version	Size	Made in	Case quantity	EAN code
Club line						
CEINTURE Belt with logo and one DOUBLEBACK LIGHT buckle 	C010BA00	blue	-	CN	40	3342540836495
	C010BA01	violet				3342540836501
Petzl book From the Deep: the Petzl Adventure: a story about a company and its environment Authors: Sophie Cuenot and Hervé Bodeau Preface by Lynn Hill 272 pages 	Z180 FR	French version	-	FR	12	3342540096431
	Z180 EN	English version			13	3342540096462
	Z180 ES	Spanish version			13	3342540100299
	Z18001 EN	English version in gift box			10	3342540096448
<i>The book "From the Deep: the Petzl Adventure" is available for download in French and English on the Petzl website.</i>						

Vertical writing area with horizontal lines.



KIT



CLASSIC

ACTIVE

PERFORMANCE

SPECIALIZED



Exploring petrified dunes at night, Arizona, United States © 2020 - Petzl Distribution - Arnaud Childevic



KIT



CLASSIC

ACTIVE

SPECIALIZED PERFORMANCE



Lighting

Petzl headlamps

Petzl headlamps from the CLASSIC, ACTIVE, PERFORMANCE and SPECIALIZED lines meet an incredibly wide range of needs, from the simplest to the most demanding, as well as different brightness requirements.



CLASSIC



ACTIVE





CLASSIC
ACTIVE
PERFORMANCE
SPECIALIZED



SWIFT RL
900 lm



DUO S
1100 lm



NAO® +
750 lm

NAO®
700 lm



TACTIKKA® +
350 lm



TACTIKKA® +RGB
350 lm



TACTIKKA®
300 lm



DUO Z2
430 lm

PERFORMANCE



SPECIALIZED



Headlamps suitable for every activity



hunting - fishing



reading



camping



hiking



urban cycling*



CLASSIC

e+LITE®		★	★	★	★	★
TIKKID®			★★★	★★★		
TIKKINA®			★★★	★★★	★★★	★
TIKKA®			★	★★★	★★★	★★★
ZIPKA®			★	★★★	★★★	



ACTIVE

BINDI®			★	★	★	★★★
ACTIK®			★	★	★	★★★
ACTIK® CORE			★	★	★	★★★



PERFORMANCE

NAO®					★	★
NAO® +					★	★
SWIFT RL			★	★	★	★



SPECIALIZED

TACTIKKA®		★★★	★	★★★	★	★
TACTIKKA® +		★★★	★	★★★	★	★
TACTIKKA® +RGB		★★★	★	★★★	★	★
DUO Z2		★				
DUO S		★				

★★★ designed for

★ possible use

* Warning: when used in an area governed by traffic regulations, Petzl lights are no substitute for required standardized lights.



running



mountaineering



trail running - orienteering



skiing



mountain biking



caving

★	★	★	★	★	★

★★★★	★				
★★★★	★★★★				
★★★★	★★★★				

★	★	★★★★	★★★★	★★★★	
★	★	★★★★	★★★★	★★★★	
★	★★★★	★★★★	★★★★	★	

		★	★	★★★★	★★★★
		★	★	★★★★	★★★★



KIT



CLASSIC

































ACTIVE

PERFORMANCE

SPECIALIZED

Summary table

			ANSI/PLATO FL 1									
												
			STANDARD LIGHTING	CONSTANT LIGHTING	REACTIVE LIGHTING	MAX BRIGHTNESS	MAX DISTANCE	MAX BURN TIME	RESERVE	LARGE	MIXED	FOCUSED
 CLASSIC												
e+LITE®		•				30 lm	7 m - 23 ft	11 h 30		•		
TIKKID®		•				20 lm	7 m - 23 ft	110 h		•		
TIKKINA®		•				250 lm	60 m - 197 ft	120 h	•	•		
TIKKA®		•				300 lm	65 m - 213 ft	120 h	•	•		
ZIPKA®		•				300 lm	65 m - 213 ft	120 h	•	•		
 ACTIVE												
BINDI®		•				200 lm	36 m - 118 ft	50 h	•	•		
ACTIK®		•				350 lm	80 m - 262 ft	120 h	•	•	•	
ACTIK® CORE		•				450 lm	90 m - 295 ft	130 h	•	•	•	
 PERFORMANCE												
NAO®			•	•		700 lm	135 m - 443 ft	12 h	•	•	•	•
NAO® +			•	•		750 lm	140 m - 459 ft	15 h	•	•	•	•
SWIFT RL		•		•		900 lm	150 m - 492 ft	10 h	•		•	
 SPECIALIZED												
TACTIKKA®		•				300 lm	65 m - 213 ft	120 h	•	•		
TACTIKKA® +		•				350 lm	90 m - 295 ft	160 h	•		•	
TACTIKKA® +RGB		•				350 lm	90 m - 295 ft	160 h	•		•	
DUO Z2			•			430 lm	120 m - 394 ft	15 h 30	•	•	•	•
DUO S			•			1100 lm	200 m - 656 ft	23 h	•	•	•	•

RED LIGHTING	RED / WHITE STROBE	RED SIGNAL	REFLECTIVE COMPONENT	HYBRID CONCEPT	PROGRAMMABLE	FACE2FACE FUNCTION	LOCK UNLOCK	GLOW IN THE DARK	RECHARGEABLE	BATTERIE INCLUDED	INGRESS PROTECTION	WEIGHT

•	• white & red						•			2 x lithium CR2032	IPX7	26 g - 1 oz
	• white			•				•		3 x AAA LR03	IPX4	80 g - 2,8 oz
				•						3 x AAA LR03	IPX4	81 g - 2,9 oz
•	• red			•				•		3 x AAA LR03	IPX4	82 g - 2,9 oz
•	• red			•				•		3 x AAA LR03	IPX4	66 g - 2,3 oz

•	• red		•				•		• USB		IPX4	35 g - 1,2 oz
•	• red		•	•			•			3 x AAA LR03	IPX4	86 g - 3 oz
•	• red		•	•			•		• USB		IPX4	75 g - 2,6 oz

							•		• USB		IPX4	185 g - 6,5 oz
		•			•		•		• USB		IPX4	185 g - 6,5 oz
			•				•		• USB		IPX4	100 g - 3,5 oz





•	• red			•						3 x AAA LR03	IPX4	82 g - 2,9 oz
•	• red			•						3 x AAA LR03	IPX4	85 g - 3 oz
red green blue	red green blue			•						3 x AAA LR03	IPX4	85 g - 3 oz
						•	•			4 x AA LR06	IP67	360 g - 12,7 oz
						•	•		• WALL		IP67	370 g - 13,1 oz





Compatibility of headlamp accessories

		NOCTILIGHT	SHELL S	SHELL L	CORE	ACCU SWIFT RL	ACCU NAO®	ACCU NAO® +	ACCU 2	KIT ADAPT
		E093DA00	E94990	E93990	E99ACA	E092DA00	E36200 2	E36200 2B	E80002	E93001



CLASSIC

e+LITE®										
TIKKID®		•		•	•					
TIKKINA®		•		•	•					•
TIKKA®		•		•	•					•
ZIPKA®		•	•		•					





ACTIVE

BINDI®			•							
ACTIK®		•		•	•					•
ACTIK® CORE		•		•	•					•

PERFORMANCE

NAO®							•			
NAO® +								•		
SWIFT RL		•		•		•				

SPECIALIZED

TACTIKKA®		•		•	•					•
TACTIKKA® +		•		•	•					•
TACTIKKA® +RGB		•		•	•					•
DUO Z2										
DUO S									•	

Mount for caving helmet	PRO ADAPT	CROCHLAMP S CROCHLAMP L	UNI ADAPT	BIKE ADAPT	Mount for cycling helmet	Mount for bicycle handlebars	NAO® belt kit	NAO® + belt kit	Quick charger	DUO S extension cord
E55940	E80004	E04350 E04405	E000BA00	E000AA00	E55920	E55930	E36R10	E36R10 2B	E55800 / E55800 UK	E55950
		•	•							
		•	•							
		•	•	•						
		•	•	•						
		•	•							
		•	•	•						
		•	•	•						
		•	•	•						
							•			
								•		
		•	•	•						
		•	•	•						
		•	•	•						
•	•	•	•	•		•				
•	•	•	•	•	•	•			•	•



Lighting performance as defined by the ANSI/PLATO FL 1 protocol

Petzl has chosen to follow the ANSI (American National Standards Institute) FL 1 protocol for measuring and communicating the lighting performance and burn times of our headlamps. This voluntary move allows the user to easily compare the lighting performance and burn times of different models of headlamps using standardized criteria.

Lighting performance: How is it measured?



- **Brightness (lumens)**

This measurement is taken between 30 and 120 seconds after the headlamp is turned on. It indicates the maximum light output, when the lamp is first turned on, using new batteries (included).



- **Lighting distance (meters)**

This is the maximum distance between the lamp and the location where only 0.25 lux of illumination remains. The measurement is taken when the lamp is turned on, using new batteries. Lighting distance depends directly on brightness, but mainly on the shape of the beam.



- **Burn time (hours)**

This corresponds to the length of time during which lighting is optimal. It is measured 30 seconds after the lamp is turned on and for as long as the lamp takes to drop to 10% of maximum light output.



- **Reserve lighting (outside scope of ANSI/PLATO FL 1 protocol)**

In addition to these measures, Petzl guarantees reserve lighting. Reserve lighting ensures a minimum light level for walking. However, the light may not be sufficient for fast-paced activities (such as running, mountain biking, skiing...).

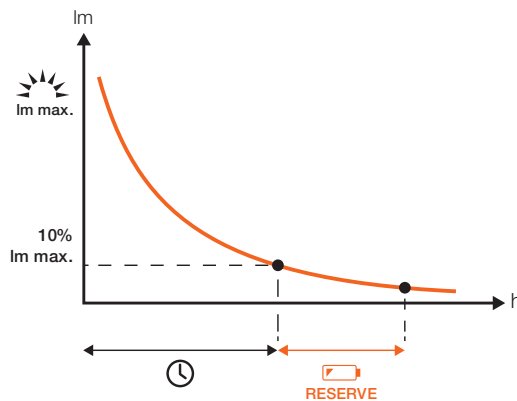

Example of a light output curve for a STANDARD LIGHTING headlamp.

Watertightness in conformity with IECX protocol: What do the IP ratings on Petzl headlamps mean?

A headlamp's watertightness is indicated by its IP rating. This index classifies the level of protection offered by equipment against intrusions by solids (e.g. dust) and liquids (e.g. water, oil).



Rating complies with the majority of headlamp uses, in rain, snow, or humidity. All Petzl headlamps are at least IPX4 rated (weather resistant).



Rating guarantees the headlamp is waterproof to -1 meter for 30 minutes in fresh water. The e+LITE headlamp is IPX7 rated.



Rating guarantees the headlamp is dustproof, and waterproof to -1 meter for 30 minutes in fresh water. DUO headlamps are IP67 rated.

Optimizing headlamp performance with different lighting levels

Petzl headlamps are designed to satisfy the user's need for burn time and/or brightness. The choice is easy, with three brightness levels, depending on the activity (except DUO headlamps).

- for a shorter activity, requiring brightness: choose the MAX POWER level, which maximizes lumens over the first few hours
- for a longer activity, requiring good burn time management: choose the STANDARD level, which offers a lumen/time balance
- for an activity requiring little movement (reading, camping): choose MAX BURN TIME, which optimizes battery life and guarantees moderate lighting for a longer time

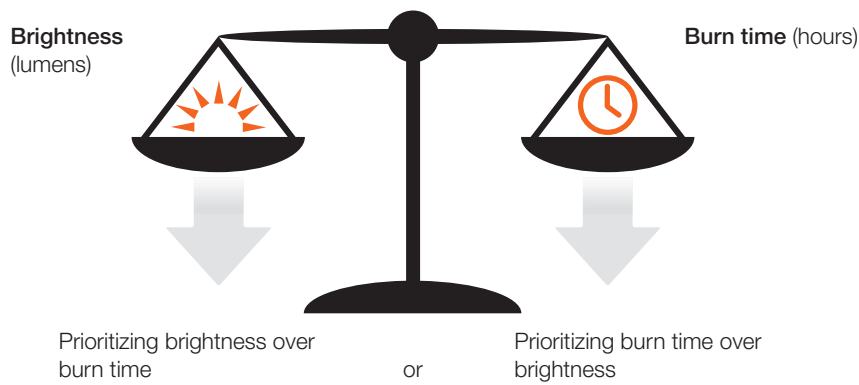

Example of table providing performance information on headlamp packaging.

		ANSI/PLATO FL 1			
					RESERVE
STANDARD LIGHTING 	MAX BURN TIME	6 lm	10 m	120 h	-
	STANDARD	100 lm	40 m	9 h	30 h*
	MAX POWER	300 lm	65 m	2 h	40 h*

*Reserve 0,25 lux - 4 m



KIT



CLASSIC

ACTIVE

PERFORMANCE

SPECIALIZED

Petzl technologies, a step ahead

Choosing the energy source to fit the need, with hybrid headlamps

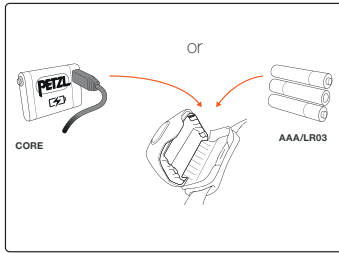

The HYBRID CONCEPT construction allows Petzl's compact headlamps to run on either the CORE rechargeable battery or three AAA/LR03 batteries, without an adapter.

- CORE rechargeable battery is an economical solution for frequent and/or intensive use
- AAA/LR03 batteries for occasional use, with very long burn time

Available on TIKKID, TIKKINA, TIKKA, ZIPKA, ACTIK, ACTIK CORE, TACTIKKA, TACTIKKA + and TACTIKKA +RGB headlamps.

Beyond power... intelligence

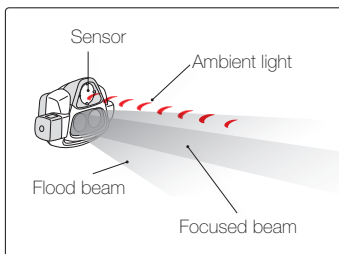

This exclusive technology, developed by Petzl, instantly provides the right lighting at the right time, without any need for manual operation. Burn time is thus optimized, and the user can remain focused on the activity. REACTIVE LIGHTING® technology provides:

- intelligent lighting
- hands-free lighting for greater convenience and performance
- longer burn time

Available on NAO, NAO + and SWIFT RL headlamps.

Consult burn time and program the headlamp with ease!

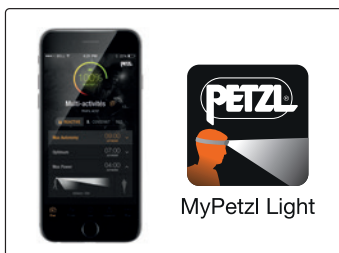

The MyPetzl Light mobile app is a simple and quick programming option: the user now has real-time info on all lighting parameters (burn time, power, modes) and can adjust them as needed, via smartphone or tablet.

Available on the NAO + headlamp. Free download at App Store and Google Play.

Face-to-face without blinding

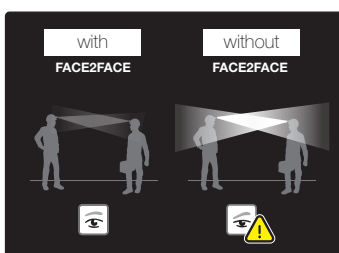

Once activated, the FACE2FACE function triggers a sensor that detects other DUO headlamps within 8 meters and automatically dims the lighting if they face each other. The light returns to its original intensity once the other headlamp is no longer in its line of sight.

Available on DUO S and DUO Z2 headlamps.



Lightweight, compact and easy to use, headlamps from the CLASSIC line provide proximity lighting for everyday family uses: camping, recreation, travel, as a back-up...

Advantages

- lightweight and compact
- long burn time
- easy to use
- 5-year guarantee (except e+LITE: 10 years)

Specifics of CLASSIC headlamps



• HYBRID CONCEPT

Headlamps compatible with three regular AAA/LR03 batteries or the CORE rechargeable battery, to choose the best energy source for the need (except e+LITE).



• Cycling accessories

Two accessories allow Petzl headlamps to be used for cycling:
 - UNI ADAPT (E000BA00): adhesive clips for any type of helmet
 - BIKE ADAPT (E000AA00): mount for handlebar or seat post

(Warning: when used in an area governed by traffic regulations, Petzl lights are no substitute for required standardized lights.)



• A flood beam

Flood, uniform lighting for comfortable close-range vision, adapted for brief movement.

Choosing a CLASSIC headlamp

	e+LITE®	TIKKID®	TIKKINA®	TIKKA®	ZIPKA®
Max. brightness	30 lm	20 lm	250 lm	300 lm	300 lm
Max. burn time	11h30	110 h	120 h	120 h	120 h
Weight	26 g	80 g	81 g	82 g	66 g
Beam and lighting types	 			 	
HYBRID CONCEPT					
GLOW IN THE DARK					
Comes with	2 x lithium CR2032	3 x AAA/LR03			



KIT

CLASSIC



ACTIVE

PERFORMANCE

SPECIALIZED

CLASSIC headlamps

	Reference	Color	Weight	 MAX BRIGHTNESS	 MAX DISTANCE	 MAX BURN TIME	Made in	Case quantity	EAN code	
CLASSIC headlamps										
e+LITE® Ultra-compact emergency headlamp. 30 lumens		E02 P4	white/black	26 g	30 lm	7 m	11h30	MY	60	3342540815643
TIKKID® Compact headlamp for children 3 years and older. 20 lumens		E091BA00	blue	80 g	20 lm	7 m	110 h	MY	50	3342540819771
		E091BA01	pink							3342540819788
DISPLAY 12 TIKKID® Display box containing twelve TIKKID headlamps (six of each color)		E091CA00	blue, pink	-	20 lm	7 m	110 h	MY	1	3342540819795
TIKKINA® Simple, compact headlamp for proximity lighting. 250 lumens		E091DA00	black	81 g	250 lm	60 m	120 h	MY	50	3342540827738
		E091DA01	red							3342540827783
		E091DA02	blue							3342540827790
		E091DA03	white							3342540827806
DISPLAY BOX TIKKINA® Display box containing twelve TIKKINA headlamps (three of each color)		E091EA00	black, red, blue, white	-	250 lm	60 m	120 h	MY	1	3342540828445
TIKKA® Compact headlamp for proximity lighting and brief movement. 300 lumens		E093FA00	black	82 g	300 lm	65 m	120 h	MY	50	3342540827745
		E093FA01	blue							3342540827752
		E093FA02	green							3342540827769
		E093FA03	white							3342540827776
ZIPKA® Simple and ultra-compact headlamp for proximity lighting and brief movement. 300 lumens		E093GA00	black	66 g	300 lm	65 m	120 h	MY	50	3342540827813
		E093GA01	green							3342540827820

	Reference	Weight	Made in	Case quantity	EAN code	
CLASSIC headlamp accessories						
CORE Rechargeable battery compatible with Petzl headlamps featuring the HYBRID CONCEPT design		E99ACA	23 g	CN	14	3342540815612
CRAVATE 6 CORE Hanger with six CORE rechargeable batteries, compatible with Petzl headlamps featuring the HYBRID CONCEPT design		E099BA00	487 g	CN	20	3342540820012

	Reference	Weight	Specifics	Made in	Case quantity	EAN code
NOCTILIGHT Protective carrying case for Petzl's compact headlamps that diffuses light into lantern mode 	E093DA00	85 g		CN	72	3342540817586
KIT ADAPT Kit for mounting a TIKKA type headlamp onto a helmet 	E93001	30 g		MY	240	3342540100800
BIKE ADAPT Plate for mounting a Petzl headlamp on bicycle handlebars or seat post 	E000AA00	40 g		MY	60	3342540828438
UNI ADAPT Adhesive clip for mounting a Petzl headlamp on any type of helmet (pack of 4)  x 4	E000BA00	10 g		MY	60	3342540828421
SHELL L Pouch for compact headlamps 	E93990	41 g		CN	60	3342540081628
SHELL S Pouch for ZIPKA and BINDI compact headlamps 	E94990	31 g		CN	60	3342540081635
CROCHLAMP S Headlamp clips for thin-edged helmets (pack of 4)  x 4	E04350	-		FR	100	3342540002616
CROCHLAMP L Headlamp clips for thick-edged helmets (pack of 4)  x 4	E04405	-		FR	40	3342540026599
Countertop or wall display for headlamps Adaptable countertop display stand on pegboard or slatwall for displaying up to 24 headlamps 	Z002AB01	10 kg	- Product dimensions: 350 x 660 x 255 mm - Package dimensions: 360 x 260 x 670 mm	FR	1	3342540832206
Floor display for sport headlamps Floor stand for displaying up to seven headlamp models and up to 88 units 	Z002AC01	38 kg	- Product dimensions: 410 x 490 x 1975 mm - Package dimensions: 1120 x 550 x 420 mm	FR	1	3342540832367
Rotating floor display for sport headlamps Rotating floor stand for displaying up to seven headlamp models, holds up to 172 units 	Z002AE01	54 kg	- Product dimensions: 610 x 610 x 2006 mm - Package dimensions: 1160 x 620 x 620 mm	FR	1	3342540832473





Exploring an ice cave under a glacier, Iceland. © 2019 - Peitz | Distribution - Arnaud Chideric

Compact and multi-beam, ACTIVE headlamps guarantee powerful, comfortable lighting. They meet the need for versatility that comes with outdoor activities like trekking, running, cycling, mountaineering, backpacking...

Advantages

- powerful lighting
- durable and rain-proof (IPX4)
- perfect weight/power balance
- 5-year guarantee (except BINDI, 3-year)

Specifics for ACTIVE headlamps



• HYBRID CONCEPT

Headlamps compatible with three regular AAA/LR03 batteries or the CORE rechargeable battery, to choose the best energy source for the need (except BINDI).



• Cycling accessories

Two accessories allow Petzl headlamps to be used for cycling:
 - UNI ADAPT (E000BA00): adhesive clips for any type of helmet
 - BIKE ADAPT (E000AA00): mount for handlebar or seat post

(Warning: when used in an area governed by traffic regulations, Petzl lights are no substitute for required standardized lights.)



• The multi-beam

Flood or mixed lighting, depending on the chosen level, to see both up close and far away (except BINDI).

Choosing an ACTIVE headlamp







	BINDI®	ACTIK®	ACTIK® CORE
Max. brightness	200 lm	350 lm	450 lm
Max. burn time	50 h	120 h	130 h
Weight	35 g	86 g	75 g
Beam and lighting types	 	 	
HYBRID CONCEPT			
Comes with	rechargeable battery	3 x AAA/LR03	CORE rechargeable battery



KIT



ACTIVE headlamps

	Reference	Color	Weight	 MAX BRIGHTNESS	 MAX DISTANCE	 MAX BURN TIME	Made in	Case quantity	EAN code	
ACTIVE headlamps										
BINDI Ultra-compact rechargeable headlamp designed for everyday athletic activities. 200 lumens 	E102AA02	emerald	35 g	200 lm	36 m	50 h	HU	76	3342540819825	
	E102AA01	orange							3342540819818	
	E102AA00	black							3342540819801	
	ACTIK® Compact multi-beam headlamp with red lighting, designed for outdoor activities. 350 lumens 	E099FA00	black	86 g	350 lm	80 m	120 h	FR	50	3342540827684
E099FA02		green	3342540827707							
E099FA01		blue	3342540827691							
ACTIK® CORE Rechargeable, compact multi-beam headlamp with red lighting, designed for outdoor activities. 450 lumens 	E099GA00	black	75 g	450 lm	90 m	130 h	FR	50	3342540828018	
	E099GA01	red							3342540828025	

	Reference	Weight	Made in	Case quantity	EAN code
ACTIVE headlamp accessories					
CORE Rechargeable battery compatible with Petzl headlamps featuring the HYBRID CONCEPT design 	E99ACA	23 g	CN	14	3342540815612
CRAVATE 6 CORE Hanger with six CORE rechargeable batteries, compatible with Petzl headlamps featuring the HYBRID CONCEPT design 	E099BA00	487 g	CN	20	3342540820012
NOCTILIGHT Protective carrying case for Petzl's compact headlamps that diffuses light into lantern mode 	E093DA00	85 g	CN	72	3342540817586
KIT ADAPT Kit for mounting a TIKKA type headlamp onto a helmet 	E93001	30 g	MY	240	3342540100800

	Reference	Weight	Specifics	Made in	Case quantity	EAN code
BIKE ADAPT Plate for mounting a Petzl headlamp on bicycle handlebars or seat post 	E000AA00	40 g		MY	60	3342540828438
UNI ADAPT Adhesive clip for mounting a Petzl headlamp on any type of helmet (pack of 4)  x 4	E000BA00	10 g		MY	60	3342540828421
SHELL L Pouch for compact headlamps 	E93990	41 g		CN	60	3342540081628
SHELL S Pouch for ZIPKA and BINDI compact headlamps 	E94990	31 g		CN	60	3342540081635
CROCHLAMP S Headlamp clips for thin-edged helmets (pack of 4)  x 4	E04350	–		FR	100	3342540002616
CROCHLAMP L Headlamp clips for thick-edged helmets (pack of 4)  x 4	E04405	–		FR	40	3342540026599
Countertop or wall display for headlamps Adaptable countertop display stand on pegboard or slatwall for displaying up to 24 headlamps 	Z002AB01	10 kg	- Product dimensions: 350 x 660 x 255 mm - Package dimensions: 360 x 260 x 670 mm	FR	1	3342540832206
Floor display for sport headlamps Floor stand for displaying up to seven headlamp models and up to 88 units 	Z002AC01	38 kg	- Product dimensions: 410 x 490 x 1975 mm - Package dimensions: 1120 x 550 x 420 mm	FR	1	3342540832367
Rotating floor display for sport headlamps Rotating floor stand for displaying up to seven headlamp models, holds up to 172 units 	Z002AE01	54 kg	- Product dimensions: 610 x 610 x 2006 mm - Package dimensions: 1160 x 620 x 620 mm	FR	1	3342540832473



KIT



CLASSIC

ACTIVE

PERFORMANCE

SPECIALIZED



Trail running at night... until daybreak © 2020 - Petzl Distribution - Arnaud Childeric

Ultra-powerful and comfortable, headlamps from the PERFORMANCE family offer intelligent lighting. They are ideal for dynamic, high-commitment activities: trail running, mountain biking, technical mountaineering, ski touring...

Advantages

- optimized burn time and brightness
- minimal handling
- work with rechargeable battery
- guaranteed 5 years (SWIFT RL) or 3 years (NAO and NAO +)

Specifics of PERFORMANCE headlamps



• Intelligent REACTIVE LIGHTING®

This exclusive technology, developed by Petzl, instantly provides the right lighting at the right time, without any need for manual operation. Burn time of the battery is thus optimized, and the user can remain focused on the activity.



• Battery with energy gauge

Gauge indicates precise battery charge level for headlamp (up to five levels, on SWIFT RL).









• Rechargeable via USB port



Choosing a PERFORMANCE headlamp

	NAO®	NAO® +	SWIFT RL
Max. brightness	700 lm	750 lm	900 lm
Max. burn time	12 h + reserve	15 h + reserve	10 h + reserve
Weight	185 g	185 g	100 g
Beam and lighting types	 	 	
REACTIVE LIGHTING			
Programmable via MyPetzl Light			
Comes with	battery that is rechargeable via USB		



PERFORMANCE headlamps

	Reference	Color	Weight	 MAX BRIGHTNESS	 MAX DISTANCE	 MAX BURN TIME	Made in	Case quantity	EAN code	
PERFORMANCE headlamps										
NAO® Ultra-powerful, rechargeable multi-beam headlamp. Features REACTIVE LIGHTING technology that automatically adapts light intensity to user needs. 700 lumens	E36AHR 2	white/black	185 g	700 lm	135 m	12 h	BG	25	3342540104310	
										
NAO® + Ultra-powerful, multi-beam rechargeable headlamp that is programmable, thanks to the MyPetzl Light app. Features REACTIVE LIGHTING technology that automatically adapts light intensity to user needs. 750 lumens	E36AHR 2 B	white/black	185 g	750 lm	140 m	15 h	BG	25	3342540105911	
										
				<i>Available in the following countries: Australia, Austria, Belgium, Bulgaria, Canada, Croatia, Cyprus, Czech Republic, Denmark, Estonia, Finland, France (except New Caledonia and Polynesia), Germany, Greece, Hungary, Iceland, Ireland, Italy, Japan, Latvia, Lithuania, Luxembourg, Malta, Netherlands, New Zealand, Norway, Poland, Portugal, Romania, Slovakia, Slovenia, Spain, Sweden, Switzerland, United Kingdom, United States</i>						
SWIFT RL Compact ultra-powerful and rechargeable headlamp with REACTIVE LIGHTING technology. 900 lumens	E095BA00 E095BA01 E095BA02	black orange blue	100 g	900 lm	150 m	10 h	HU	48	3342540828506 3342540828513 3342540828520	
										

	Reference	Weight	Made in	Case quantity	EAN code
PERFORMANCE headlamp accessories					
ACCU NAO® Rechargeable battery for NAO headlamp	E36200 2	95 g	BG	120	3342540104327
					
ACCU NAO® + Rechargeable battery for NAO + headlamp	E36200 2 B	95 g	BG	120	3342540105928
					
ACCU SWIFT RL Rechargeable battery for SWIFT RL headlamp	E092DA00	50 g	CN	186	3342540828544
					
NAO® belt kit Extension cord and belt clip for NAO headlamp	E36R10	59 g	BG	78	3342540092891
					
NAO® + belt kit Extension cord and belt clip for NAO + headlamp	E36R10 2 B	59 g	BG	78	3342540105904
					
UNI ADAPT Adhesive clip for mounting a Petzl headlamp on any type of helmet (pack of 4)	E000BA00	10 g	MY	60	3342540828421
 x 4					

	Reference	Weight	Specifics	Made in	Case quantity	EAN code
NOCTILIGHT Protective carrying case for Petzl's compact headlamps that diffuses light into lantern mode 	E093DA00	85 g		CN	72	3342540817586
SHELL L Pouch for compact headlamps 	E93990	41 g		CN	60	3342540081628
CROCHLAMP S Headlamp clips for thin-edged helmets (pack of 4)  x 4	E04350	-		FR	100	3342540002616
CROCHLAMP L Headlamp clips for thick-edged helmets (pack of 4)  x 4	E04405	-		FR	40	3342540026599
Countertop or wall display for headlamps Adaptable countertop display stand on pegboard or slatwall for displaying up to 24 headlamps 	Z002AB01	10 kg	- Product dimensions: 350 x 660 x 255 mm - Package dimensions: 360 x 260 x 670 mm	FR	1	3342540832206
Floor display for sport headlamps Floor stand for displaying up to seven headlamp models and up to 88 units 	Z002AC01	38 kg	- Product dimensions: 410 x 490 x 1975 mm - Package dimensions: 1120 x 550 x 420 mm	FR	1	3342540832367
Rotating floor display for sport headlamps Rotating floor stand for displaying up to seven headlamp models, holds up to 172 units 	Z002AE01	54 kg	- Product dimensions: 610 x 610 x 2006 mm - Package dimensions: 1160 x 620 x 620 mm	FR	1	3342540832473





Nakanat expedition in Papua New Guinea © 2018 - Petzl Distribution - J F Fabriot

Hunting and fishing

Lightweight and compact, these headlamps offer lighting colors that preserve night vision and stealth, for activities like hunting, fishing, nature watching...

Advantages

- powerful lighting
- durable and rain-proof (IPX4)
- discreet lamp colors (black, camo, desert) and lighting colors
- 5-year guarantee

Specifics of SPECIALIZED hunting and fishing headlamps



• HYBRID CONCEPT

Headlamps compatible with three regular AAA/LR03 batteries or the CORE rechargeable battery, for choosing the best energy source for the need.



• Lighting for guaranteed stealth

Red, green or blue lighting preserves night vision and stealth, or optimizes reading a map at night.



• A mixed beam

Flood and focused lighting for both proximity and distance vision (except TACTIKKA).

Choosing a SPECIALIZED hunting and fishing headlamp





	TACTIKKA®	TACTIKKA® +	TACTIKKA® +RGB
Max. brightness	300 lm	350 lm	350 lm
Max. burn time	120 h	160 h	160 h
Weight	82 g	85 g	85 g
Beam and lighting types			
HYBRID CONCEPT			
Comes with	3 x AAA/LR03		



SPECIALIZED headlamps

	Reference	Color	Weight	 MAX BRIGHTNESS	 MAX DISTANCE	 MAX BURN TIME	Made in	Case quantity	EAN code	
SPECIALIZED headlamps for hunting and fishing										
TACTIKKA® Compact headlamp ideal for hunting and fishing. White or red lighting to preserve night vision and ensure stealth. 300 lumens	 E093HA00	black	82 g	300 lm	65 m	120 h	MY	50	3342540827837	
	 E093HA01	camo							3342540827844	
	 E093HA02	desert							3342540827851	
TACTIKKA® + Compact and powerful headlamp, ideal for hunting and fishing. White or red lighting to preserve night vision and ensure stealth. 350 lumens	 E089EA00	black	85 g	350 lm	90 m	160 h	FR	50	3342540827868	
	 E089EA01	camo							3342540827875	
	 E089EA02	desert							3342540827882	
TACTIKKA® +RBG Compact and powerful headlamp, ideal for hunting and fishing. White or red/green/blue lighting to preserve night vision and ensure stealth. 350 lumens	 E089FA00	black	85 g	350 lm	90 m	160 h	FR	50	3342540827899	
	 E089FA01	camo							3342540827905	
	 E089FA02	desert							3342540827912	

	Reference	Weight	Made in	Case quantity	EAN code
Accessories for SPECIALIZED headlamps for hunting and fishing					
CORE Rechargeable battery compatible with Petzl headlamps featuring the HYBRID CONCEPT design	 E99ACA	23 g	CN	14	3342540815612
CRAVATE 6 CORE Hanger with six CORE rechargeable batteries, compatible with Petzl headlamps featuring the HYBRID CONCEPT design	 E099BA00	487 g	CN	20	3342540820012
NOCTILIGHT Protective carrying case for Petzl's compact headlamps that diffuses light into lantern mode	 E093DA00	85 g	CN	72	3342540817586
KIT ADAPT Kit for mounting a TACTIKKA type headlamp onto a helmet	 E93001	30 g	MY	240	3342540100800
BIKE ADAPT Plate for mounting a Petzl headlamp on bicycle handlebars or seat post	 E000AA00	40 g	MY	60	3342540828438
UNI ADAPT Adhesive clip for mounting a Petzl headlamp on any type of helmet (pack of 4)	 E000BA00 x 4	10 g	CN	60	3342540081635

	Reference	Weight	Specifics	Made in	Case quantity	EAN code
SHELL L Pouch for compact headlamps 	E93990	41 g		CN	60	3342540081628
CROCHLAMP S Headlamp clips for thin-edged helmets (pack of 4)  x 4	E04350	-		FR	100	3342540002616
CROCHLAMP L Headlamp clips for thick-edged helmets (pack of 4)  x 4	E04405	-		FR	40	3342540026599
Countertop or wall display for headlamps Adaptable countertop display stand on pegboard or slatwall for displaying up to 24 headlamps 	Z002AB01	10 kg	- Product dimensions: 350 x 660 x 255 mm - Package dimensions: 360 x 260 x 670 mm	FR	1	3342540832206
Floor display for sport headlamps Floor stand for displaying up to seven headlamp models and up to 88 units 	Z002AC01	38 kg	- Product dimensions: 410 x 490 x 1975 mm - Package dimensions: 1120 x 550 x 420 mm	FR	1	3342540832367
Rotating floor display for sport headlamps Rotating floor stand for displaying up to seven headlamp models, holds up to 172 units 	Z002AE01	54 kg	- Product dimensions: 610 x 610 x 2006 mm - Package dimensions: 1160 x 620 x 620 mm	FR	1	3342540832473



KIT



SPECIALIZED

SPECIALIZED headlamps

Caving, orienteering races and cycling

Ultra-powerful, waterproof and rechargeable, these headlamps offer lighting adapted to activities that are demanding or done in a group.

Advantages

- very powerful lighting
- watertight and durable
- work with standard or rechargeable batteries
- 3-year guarantee

SPECIALIZED caving, orienteering and cycling headlamp features



• FACE2FACE

Function allows users to be face-to-face without blinding one another.



• Simple rotating knob

Simple and ergonomic rotating knob for easy handling, even with gloves.



• Adaptable

Plates for mounting, sticking or fastening onto any type of helmet (caving, cycling, skiing...) or bicycle handlebar, in order to install a DUO headlamp.

- mounting plates: SIROCCO ADAPT (E103BA00), for cycling helmet (E55920) and for bicycle handlebar (E55930)
- PRO ADAPT stick-on plates (E80004)
- screw-on plates (E55940)

For non-Petzl helmets, verify compatibility with the helmet manufacturer.

Choosing a SPECIALIZED caving, orienteering and cycling helmet









	DUO Z2	DUO S
Max. brightness	430 lm	1100 lm
Max. burn time	15h30 + reserve	23 h + reserve
Weight	360 g	370 g
Beam type		
FACE2FACE		
Rotating knob		
Comes with	4 x AA/LR06	ACCU 2 rechargeable battery

Reference	Version	Weight	MAX BRIGHTNESS	MAX DISTANCE	MAX BURN TIME	Made in	Case quantity	EAN code	
SPECIALIZED headlamps for caving, orienteering races, and cycling									
DUO Z2 Powerful, waterproof and durable headlamp, featuring FACE2FACE anti-glare function. 430 lumens 	E80AHB	-	360 g	430 lm	120 m	15h30	MY	6	3342540105829
	DUO S Ultra-powerful, waterproof and rechargeable headlamp, featuring Petzl's FACE2FACE anti-glare function. 1100 lumens 	E80CHR	-	370 g	1100 lm	200 m	23 h	MY	6
E80CHR UK		UK							
BOREO® CAVING Caving helmet with mounting plates for DUO headlamp 	A042SA00	size S/M	325 g	-	-	-	FR	8	3342540820722
	A042SA01	size M/L	335 g						3342540820739

Reference	Weight	Made in	Case quantity	EAN code	
Accessories for SPECIALIZED headlamps for caving, orienteering races and cycling					
SIROCCO ADAPT Accessory for mounting a DUO headlamp on a SIROCCO helmet 	E103BA00	35 g	CN	32	3342540820715
PRO ADAPT Adhesive accessory for mounting a DUO headlamp on any type of helmet 	E80004	48 g	MY	48	3342540105881
Mount for caving helmet Front and back plates for mounting DUO headlamps on caving helmets 	E55940	40 g	FR	12	3342540089440
ACCU 2 Rechargeable battery for DUO S headlamp 	E80002	168 g	MY	60	3342540105874
Quick charger Quick wall charger for ACCU 2 and ACCU 4 ULTRA rechargeable batteries 	E55800	145 g	CN	36	3342540076259
	E55800 UK				3342540825758



SPECIALIZED headlamps

	Reference	Weight	Specifics	Made in	Case quantity	EAN code
Mount for cycling helmet Plates for mounting DUO S headlamp on cycling and mountain biking helmets with thick or thin edges 	E55920		- on ventilated helmet: 30 g - on helmet with thin edge: 40 g	CN	56	3342540089464
Extension cord for headlamp Extension power cable for DUO S headlamp 	E55950	75 g		CN	20	3342540076310
Mount for bicycle handlebars Plates for mounting DUO headlamps on bicycle handlebars 	E55930	175 g		CN	32	3342540089457
UNI ADAPT Adhesive clip for mounting a Petzl headlamp on any type of helmet (pack of 4)  x 4	E000BA00	10 g		MY	60	3342540828421
CROCHLAMP S Headlamp clips for thin-edged helmets (pack of 4)  x 4	E04350	-		FR	100	3342540002616
CROCHLAMP L Headlamp clips for thick-edged helmets (pack of 4)  x 4	E04405	-		FR	40	3342540026599
Countertop or wall display for headlamps Adaptable countertop display stand on pegboard or slatwall for displaying up to 24 headlamps 	Z002AB01	10 kg	- Product dimensions: 350 x 660 x 255 mm - Package dimensions: 360 x 260 x 670 mm	FR	1	3342540832206
Floor display for sport headlamps Floor stand for displaying up to seven headlamp models and up to 88 units 	Z002AC01	38 kg	- Product dimensions: 410 x 490 x 1975 mm - Package dimensions: 1120 x 550 x 420 mm	FR	1	3342540832367
Rotating floor display for sport headlamps Rotating floor stand for displaying up to seven headlamp models, holds up to 172 units 	Z002AE01	54 kg	- Product dimensions: 610 x 610 x 2006 mm - Package dimensions: 1160 x 620 x 620 mm	FR	1	3342540832473

DESCENDERS



Upper bobbin for SIMPLE
EAN: 3342540001800



D09100
Lower bobbin + handle for STOP
EAN: 3342540001923



D09150
Upper bobbin for STOP
EAN: 3342540001930

ICE AXES



U21900
GRIPREST palm rest for NOMIC
EAN: 3342540070530



69108
3 bolts for QUARK
EAN: 3342540050006



U15AAL
ALPIX, spare pick for SUM'TEC
EAN: 3342540081499



U21700
GRIPTAPE grip tape
EAN: 3342540070523



U19GR2
GRIPREST QUARK
EAN: 3342540089082



U19 TRI
TRIGREST QUARK
EAN: 3342540089075

MISCELLANEOUS

FR0083
Steel Delta n° 5 maillon
EAN: 3342540004290

CRAMPONS



T10950
2 reversible curved linking bars L
EAN: 3342540065529



79550
2 front rivets for SPIKY PLUS
EAN: 3342540795501



79545
4 rear points for SPIKY PLUS
EAN: 3342540795457



T05850
SPIRLOCK, LEVERLOCK, FLEXLOCK
strap kit
EAN: 3342540060685



T23900
ANTISNOW for M10
EAN: 3342540060784



T05960
ANTISNOW for VASAK and SARKEN
EAN: 3342540071995



T23800
2 blades for M10
EAN: 3342540060760

ANCHORS



P08100
8 mm Ø threaded tip + pin for
TAMPONNOIR
EAN: 3342540008557



P36GA 10
Steel bolt for 10 mm hanger
EAN: 3342540104228



P36GA 12
Steel bolt for 12 mm hanger
EAN: 3342540104259



P36GS 10
Stainless steel bolt for 10 mm hanger
EAN: 3342540104211



P36GS 12
Stainless steel bolt for 12 mm hanger
EAN: 3342540104242



P36GH 12
HCR904 stainless steel bolt for 12 mm
hanger
EAN: 3342540104235

HEADLAMPS



E51999
Spare headband for DUO and ULTRA®
EAN: 3342540076457



E092EA00
Spare headband for SWIFT RL, REACTIK
and REACTIK +
EAN: 3342540828537



E91001
Spare headband for TIKKINA® and
TIKKA®
EAN: 3342540102583



E97001
Spare headband for TIKKA® + and
TIKKA® XP
EAN: 3342540102576



E099CA00
Spare headband for ACTIK and ACTIK
CORE
EAN: 3342540821385



E00100
ADAPT headband
EAN: 3342540070943



E00300
ADAPT helmet mount
EAN: 3342540070912



E04999
Elastic headband for universal and
specialized headlamps
EAN: 3342540034419



E43900
ADAPT connection plate for TIKKA® family
EAN: 3342540072091

MADE IN

BD : Bangladesh
BG : Bulgaria
CN : China
CZ : Czech Republic
DE : Germany
FR : France
GB : Great Britain
HU : Hungary
IT : Italy
LK : Sri Lanka
MY : Malaysia
RO : Romania
TW : Taiwan
VN : Vietnam

Product index

Product	Reference	Page	Product	Reference	Page	Product	Reference	Page
8003	C05 1N/2N	34	CLUB 10 mm	R39AO 040/060/070 R39AW 040	54	E		
2 reversible linking bars L	T20850	72	CLUB 200 10 mm	R39AO 200 R39AW 200	54	e+LITE®	E02 P4	114
A			COEUR BOLT HCR	P36BH 12	86	ELASTIC STRAP	U001CA00	71
ACCU 2	E80002	129	COEUR BOLT STAINLESS	P36BS 10/12	86	Equipment holder for CANYON CLUB harness	C086GA00	35
ACCU NAO®	E36200 2	122	COEUR BOLT STEEL	P36BA 10/12	86	ERGONOMIC	U022AA00	65
ACCU NAO® +	E36200 2B	122	COEUR HCR	P36AH 12	86	EVOLV ADJUST	L35ARD	94
ACCU SWIFT RL	E092DA00	122	COEUR PULSE	P37S 12	87	EXPLO	C027AA00	14, 35
ACTIK®	E099FA00/1/2	118	COEUR STAINLESS	P36AS 10/12	86	EXPRESS	C040AA00/1/2	61
ACTIK® CORE	E099GA00/1	118	COEUR STEEL	P36AA 10/12	86	Extension cord for headlamp	E55950	130
ADJAMA	C022BA00/1/2/3	10, 33	COLLINOX	G100AA00	87	F		
ALCANADRE	S64A	93	Comfort foam for CANYON CLUB harness	C086FA00	35	FAKIR pouch	V01	72
ALTITUDE®	C019AA00/1/2	13, 33	CONGA® 8.0 mm	R42AB 020/030	55	FIFI	V12	94
ALTO	K02AO	91	CONNECT ADJUST	L034AA00	21, 82	FIL	T03A FIL	71
Am'D	M34A SL/BL/RL	59	CONTACT® 9.8 mm	R33AC 060/070/080 R33AD 060/070/080	18, 53	FIL FLEX	T03A FF	71
AMPOULE BAT'INOX	G103AA00	87	CONTACT®WALL 9.8 mm	R33AC 030/040	18, 53	FIL SMALL	U001FA00	71
AMPOULE COLLINOX	G101AA00	87	CORAX	C051AA00/1, C051BA00/1, C051CA00/1	12, 34	FIL TELEMARK	T03600	71
ANGE FINESSE	M057AA00/1 M057BA00 M057CA00	60	CORD-TEC pouch	U003BA00	72	FINESSE	C042AA00/1	61
ANGE L	M59 B/G	59	CORD-TEC replacement cord	T01A COR	72	FLEX	T03A BS	72
ANGE S	M57 O/G	59	Cords	R044AA00 R045AA00 R046AA00 R047AA00	55	Floor display for sport headlamps	Z002AC01	115, 119, 123, 127, 130
ANNEAU	C40A 60/80/120/150	89	CORE	E99ACA	114, 118, 126	FLY	C002AA00/1/2	12, 33
Anodized, fixed brake bar for RACK	D11300	47	CORDEX	K52 SN/MN/LN/XLN/ XST/ST/MT/LT/XLT	94	FIXE	P05SO	78
ANTISNOW	T03A AS T05A AS	72	CORDEX PLUS	K53 SN/MN/LN/XLN/ XST/ST/MT/LT/XLT	95	FOOTAPE	C47A	76
ANTISNOW DART	U001DA00	72	COUDEE	G105AA00	87	FOOTCORD	C48A	76
ANTISNOW LEOPARD	T01A AS	72	Countertop or wall display for headlamps	Z002AB01	123, 127, 130	FRACTIO	C16 16/26	33
ANTISNOW LYNX®	T24960	72	CRAVATE 6 CORE	E099BA00	114, 118, 126	FREELOCK	U81000	66
AQUILA	C037AA00/1/2/3/4	33	CROCHLAMP L	E04405	115, 119, 123, 127, 130	FREINO	M42	59
ARIAL® 9.5 mm	R34AC 060/070/080 R34AD 060/070/080	17, 53	CROCHLAMP S	E04350	115, 119, 123, 127, 130	FREINO Z	M042AA00	46
ASCENSION	B17ALA B17ARA	76	CROLL® L	B016AA00	76	G		
ATTACHE	M38A SL	59	CROLL® S	B16BAA	76	GEMINI	P66A	78
AVEN	C013AA00/1	13, 35	Cutaway sling for CANYON CLUB harness	C086DA00	35	GLACIER	U01B 060/068/075	65
AXESS	C041AA00/1	61	Cutaway sling for CANYON GUIDE harness	C086EA00	35	GLACIER LITERIDE	U01B 050	65
B			D			GO 8 mm	P015AA00/1	26, 88
Bag for NEST litter	S062AA00	27, 94	D-LYNX	T25	70	GOUTTE D'EAU	P06 2	95
BACK FLEX	T03A BFL	71	DART	U001AA00	70	GRADISTEP	C08	95
BACK LEVER	U001BA00	71	DART crampon front sections	U001EA00	71	GRIGRI®	D014BA00/1/2	46
BANDI	S038BA00/1	26, 93	DELTA	P11	88	GRIGRI® +	D13A G/AG/VI	46
BARRETTE	T03A BA	72	DEMI ROND	P18	88	GRIPREST	U022CA00	66
BASIC	B18BAA	76	DISPLAY 12 TIKKID®	E091CA00	114	GRIPREST NOMIC	U021DA00	66
BAT'INOX	G102AA00	87	DISPLAY BOX	E091EA00	114	GULLY	U014AA00 U014BA00	65
BIKE ADAPT	E000AA00	115, 119, 126	TIKKINA®	E091EA00	114	H		
BINDI	E102AA00/1/2	118	DJINN	M060AA00 M060BA00/1	60	HIRUNDOS	C036AA00/1/2/3/4	33
BODY	C018BA00	34	DJINN AXESS	M060CA00/1/2	60	HUIT	D02	46
BOLTBAG	C11 A	88	DRY	U19 DRY	64	HUIT ANTIBRULURE	D01	46
BONGO	P27	88	K			ICE	U19 ICE	66
BOREA	A048AA00, A048BA00, A048CA00	40	DUAL CANYON CLUB	L086AB00	23, 82	IRVIS® crampon front sections	T03A AV	71
BOREO	A042EA00/1, A042FA00/1, A042GA00/1, A042HA00/1	40	DUAL CANYON GUIDE	L086BB00	23, 82	IRVIS® HYBRID	T02A LLU	70
BOREO CAVING	A042SA00/1	40, 129	DUAL CONNECT ADJUST	L035BA00	21, 82	IRVIS®	T03A LLU/FL	70
Brake bar w/o hook for RACK	D11200	47	DUAL CONNECT VARIO	L087AA00	22, 82	I		
BUG	S073AA00/1	93	DUO S	E80CHR E80CHR UK	129	ICE	U19 ICE	66
C			DUO Z2	E80AHB	129	IRVIS® crampon front sections	T03A AV	71
CANYON CLUB	C086AA00	15, 35	L			IRVIS® HYBRID	T02A LLU	70
CANYON GUIDE	C086BA00/1	16, 35	KAB	S011AA00	55, 93	IRVIS®	T03A LLU/FL	70
CARITOOL	P42	35	KIT ADAPT	E93001	115, 118, 126	J		
CARITOOL EVO	P42 M	35	KIT CORAX GRIGRI Sm'D	K032AA00/1	24, 84	ICE	U19 ICE	66
CARNET	S90 - S91	96	KIT CORAX YSI Sm'D	K031AA00/1	24, 84	IRVIS® crampon front sections	T03A AV	71
CEINTURE	C010AA00/1	96	KIT CORD-TEC	U001GA00	71	IRVIS® HYBRID	T02A LLU	70
CIRRO	K01AO	91	KIT SECOURS CREVASSE	K025AA00	78, 84	IRVIS®	T03A LLU/FL	70
CLASSIQUE 22L	C03 2	94	KIT VIA FERRATA EASHOOK	K029DA00/1	25, 82, 84	K		
CLIPPER	U80000	66	KIT VIA FERRATA VERTIGO	K029CA00/1	25, 82, 84	KAB	S011AA00	55, 93

Product	Reference	Page
L		
LASER	G050AA00/1/2	86
LASER SPEED LIGHT	G052AA00/1/2	86
LASER SPEED 10 cm	G051AA00/1/2	86
LASER SPEED	G051AA03	86
LEOPARD LLF	T01A LLF	70
LEOPARD FL	T01A FL	70
LIM'ICE	V70	86
LINKIN	U82002	67
LIVANOS	65504 65506 65508 65510	87
LOOPING	C25	95
LUNA	C035BA00/1/2/3	10, 33
LYNX®	T24A LLU	70
LYNX® front point kit	T24850	71
M		
MACCHU®	C015AA00/1	34
MAILLON RAPIDE N° 5	P49100	94
MAMBO® 10.1 mm	R32AC 050/060/070 R32AD 050/060/070	19, 53
MARTEAU	U19 MAR	66
MASSELOTTES	U021EA00	67
METEOR	A071AA00/1/2/3/4/5	40
MICRO TRAXION	P53	78
MINI	P59A	78
MINI MARTEAU	U021BA00	66
Mount for caving helmet	E55940	129
Mount for cycling helmet	E55920	130
Mount for bicycle handlebars	E55930	130
MULTIHOOK	U002AA00	86
N		
NANO TRAXION	P053AA00	20, 78
NAO®	E36AHR 2	122
NAO® +	E36AHR 2B	122
NAO® belt kit	E36R10	122
NAO® + belt kit	E36R10 2B	122
NIMBO	K03AO	91
NEST	S061AA00	27, 94
NOCTILIGHT	E093DA00	115, 114, 123, 126
NOMIC	U021AA00	65
O		
OCTO	U010AA00	86
OK	M33A SL/TL/BL	59
OMNI	M37 SL/TL	59
OSCILLANTE	P02A	78
OUISTITI	C068AA00	34
P		
Pack of 6 DJINN AXESS quickdraws	M060DA00	61
PANNE	U19 PAN	66
PANTIN®	B02CLA B02CRA	76
PARTNER	P52A	78
PASO® GUIDE 7.7 mm	R22BG 050/060/070 R22BO 050/060/070	54
PAW S	G063AA00	88
PERFO SPE	P08	88
PERSONNEL 15L	S44Y 015	94
Petzl book	Z180 FR/EN/ES Z18001 EN	96
PICCHU	A049AA00/1	15, 40
PICK AND SPIKE PROTECTION	U82003	67

Product	Reference	Page
PIRANA	D005AA00/1	22, 47
PORTAGE 30L	S43Y 030	94
POWER BALL	P22AB 040	93
POWER CRUNCH	P22AS 100/200	93
POWER CRUNCH BOX	P22AX 100	93
POWER LIQUID	P22AL 200	93
PRO ADAPT	E80004	129
PRO TRAXION	P51 A	78
PROTEC	C45 N	88
Protective seat for CANYON harnesses	C086CA00/1/2	35
Pulley for SIMPLE	D004CA00	47
PULSE	P37S 8	87
PUR'ANNEAU	G006AA00/1/2	89
PUR'DRY	U022BA00	66
PUR'ICE	U021CA00	66
PUR LINE 6 mm	R010AA00/1	19, 55
PUSH 9 mm	R40AO 040/060/070 R40AW 040	54
PUSH 200 9 mm	R40AO 200 R40AW 200	54
Q		
QUARK	U019BA00 U019AA00	65
Quick charger	E55800/E55800 UK	129
QUICKSTEP	C09	95
R		
RACK	D11	46
RAD LINE 6 mm	R011AA00/1	55
RAD SYSTEM	K011AA00	55, 84
REGLETTE	P06 1	94
Replacement foam for CLUB helmets	A042MA01	41
Replacement foam for Petzl helmets	A042MA00	41
RESCUE	P50A	78
REVERSO®	D017AA00/1/2	46
RIDE	U04A 45	65
ROCHER MIXTE	65106 65108 65110	87
ROCPEC	P26	88
ROCPEC ADP	P26250	88
Rotating floor display for sport headlamps	115, 119, Z002AE01 123, 127, 130	
RUMBA® 8 mm	R21BR 050/060 R21BB 050/060	54
S		
SAKA	S039BA00/1	26, 93
SAKAB	S037AA00	93
SAKOVER	S036AA00	93
SAKAPOCHE	S040AA00/1	93
SAMA	C021BA00/1/2/3	11, 33
SARKEN	T10A LLU	70
SARKEN crampon front sections	T10A AV	71
SEGMENT 8 mm	R076AA06	55
SCORPIO EASHOOK	L060BA00	82
SCORPIO VERTIGO	L060AA00	82
SELENA	C055BA00/1/2/3	11, 33
SHELL L	E93990	115, 119, 123, 127
SHELL S	E94990	115, 119
SHUNT	B03B	94
SIMBA	C65	34
SIMPLE	D004AA00	46
SIROCCO®	A073AA00/1 A073BA00/1	40
SIROCCO ADAPT	E103BA00	129
SITTA	C10AO S/M/L	33
Sm'D	M39A SL/RL	59
Sm'D WALL	M39A S	58
SPATHA	S92AY/S92AB	96

Product	Reference	Page
SPEEDY	G106AA00	88
SPELEGYCA	L002AA00	82
SPIRIT	M53 S/B	60
SPIRIT EXPRESS	M053AA00/1	60
SPIRIT SCREW-LOCK	M53A SL	59
ST'ANNEAU	C07 24/60/120	89
STEF	S059AA00	27, 94
STEF for NEST litter before 2020	S059BA00	94
STOP	D009AA00	46
STRING	M090AA00	61
SUM'TEC	U015AA00 U015BA00	65
SUMMIT®	U13B 052/059/066	65
SUMMIT® EVO	U14B 052/059/066	65
SUPERAVANTI	C012AA00/1	13, 35
SWIFT RL	E095BA00/1/2	122
Swinging brake bar with hook for RACK	D11250	47
SWIVEL S	P58 S	88
T		
TACTIKKA®	E093HA00/1/2	126
TACTIKKA® +	E089EA00/1/2	126
TACTIKKA® +RGB	E089FA00/1/2	126
TAM TAM	P16	88
TANDEM®	P21	78
TANDEM® SPEED	P21 SPE	78
TANGO® 8.5 mm	R20AW 050/060 R20AB 050/060	54
TARP	S012AA00	20, 55, 93
TIBLOC	B01B	78
TIKKA®	E093FA00/1/2/3	114
TIKKID®	E091BA00/1	114
TIKKINA®	E091DA00/1/2/3	114
TORSE	C026AA00	14, 35
TOUR	C020AA00/1/2 SM/ML/LXL	34
TRANSPORT 45L	S42Y 045	94
TRIGREST	U016AA00	66
U		
U	65312 65314	87
ULTRALEGERE	P00A	78
ULTRALIGHT pouch	U003AA00	72
UNI ADAPT	E000BA00	115, 119, 122, 126, 130
UNIVERSEL	P17 5/7/9	87
V		
V CONIQUE	66007 66011	87
V-LINK	U083AA00	67
VASAK®	T05A LLU/FL	70
VASAK® crampon front sections	T05A AV	71
VERSO	D019AA00/1	46
VERTIGO		
WIRE-LOCK	M40A WLU	59
VOLTA® 9.2 mm	R35AN 050/060/070/080 R35AO 030/050/060/ 070/080/100	53
VOLTA®	R36AO 030/40/50/60	
GUIDE 9 mm	R36AO 080/100	16, 53
VOLTIGE	C60	34
VRILLEE	G104AA00	87
W		
WILLIAM	M36A SL/BL	59
Y		
YSI	D018AA00/1/2	15, 46
Z		
ZIPKA®	E093GA00/1	114



Rope access and confined space

Rope access work often involves environments at significant height. Work done in confined spaces entails challenges related to the lack of space and lack of means of autonomous progression.



Tree care

Not all tree work can be done using exterior means such as elevated platforms or ladders. In this case, to move and work, the arborist uses rope progression techniques.



Framing and roofing

In this type of work situation, the risk of slipping and falling is higher. A fall arrest system must therefore be installed to guard against these hazards.



Energy and networks

These environments are characterized by structures such as towers, antennas and wind turbines. The means of progression are varied and dependent directly on the structure, which does not always have a fall-arrest system in place.



Self-rescue

A firefighter who finds himself or herself trapped inside a burning structure must be prepared for self-evacuation and have the appropriate equipment on hand.



Hazardous areas

Where there is risk of explosion, the hazardous locations are classified by zone (ATEX and/or HAZLOC). All of the materials used must therefore conform with current regulations for this type of zone.



Technical rescue

Every day, rescue workers must adapt to new and dangerous situations, and require significant material support. Petzl proposes innovative, versatile and high-performance solutions to facilitate these missions.



Maintenance and workshops

Professionals working at concerts and shows, in workshops, in maintenance, in the energy and networks sector... all require practical and lightweight headlamps on a daily basis.



Tactical special forces

Tactical operations in a hostile environment require maximum safety in every situation, so being able to count on the quality and performance of the equipment is essential.



Exploring new horizons

Reaching a summit or progressing in the vertical world gives rise to enduring passions that help women and men grow, thrive and dream. For over 15 years, the Petzl Foundation's mission has been to support and initiate public interest projects through its activities in mountainous and vertical domains, projects that help bring balance to humankind's place in our natural, cultural, and economic environments.



© Serge Caillault

Encouraging learning and risk management to avoid accidents.



© Philippe Pezalla

Promoting the preservation of hard-to-access ecosystems.



© Sarah Del Ben / Fondation UGA

Contributing to enhanced understanding of best practices in the vertical world.

Avalanche risk: preparing for an excursion with the Yéti and Skitourenguru applications



© Marc Daviet

Choosing a route suited to the most current snow conditions is key to reducing the risk of being caught in an avalanche. During this preparation phase, the role of digital tools is growing, thanks to community websites and to the availability of online geographical data. Since December 2019, snow sport enthusiasts have had access to Yéti and Skitourenguru, two free web applications that help them make good early planning decisions.

In the last four decades, avalanches have killed an average of 31 people every year in the mountains of France. In almost every case, this involved snow sports: ski touring, back-country skiing or snowshoeing.

Too often overlooked, advance route-planning appears to be the key to limiting accidents. During this planning phase, Yéti and Skitourenguru help snow sport enthusiasts choose a suitable and safe route by identifying key passages, factors for consideration and options for retreat. Yéti and Skitourenguru allow users to make more informed decisions, providing all the information available the day prior to departure, in order for them to anticipate and better manage the risk before heading out.

Yéti is available to the general public on the Camptocamp community site: www.camptocamp.org/yeti.

Skitourenguru.ch has been available in Switzerland since 2014. Available to French users in the Belledonne, Lauzière and Beaufortin massifs as of December 2019, it is being gradually rolled out across France's mountain ranges: www.skitourenguru.ch.

These apps were created through a competition held by the National Institute of Geographic and Forestry Information (IGN), the École nationale des sciences géographiques (ENSG), Skitourenguru.ch, and Camptocamp.org and with the support of the Petzl foundation.

To learn more about these apps, visit the Petzl Foundation site.

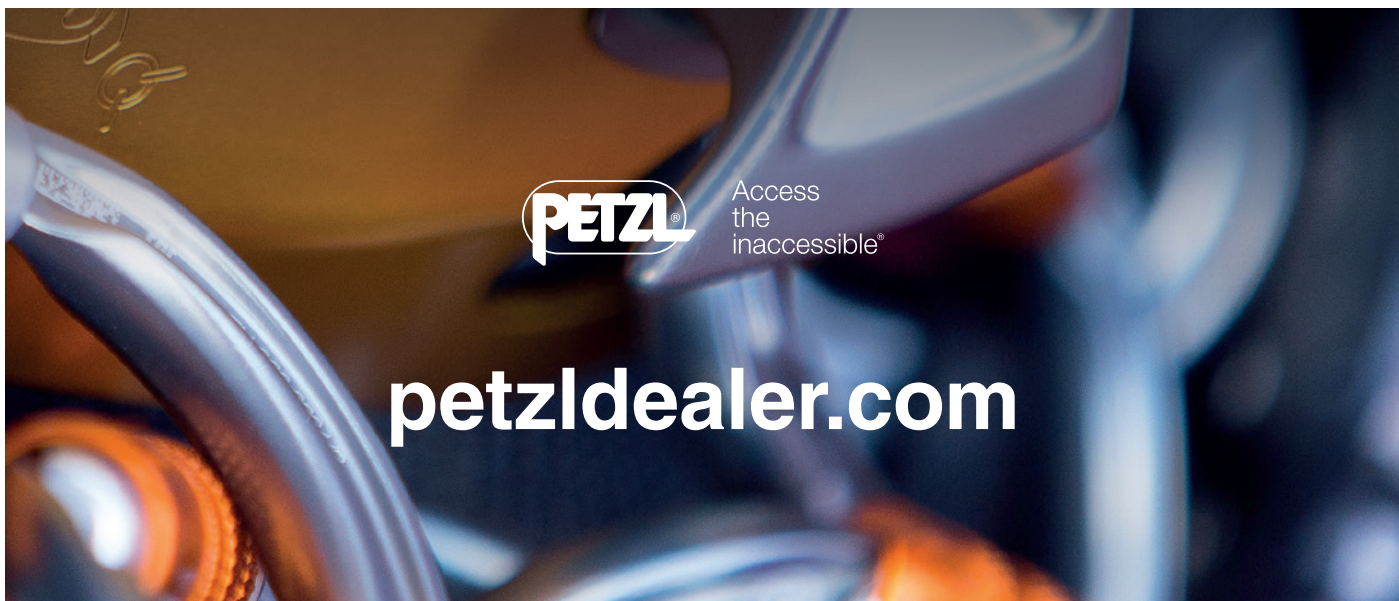

Order products and download information easily

Petzdealer.com, the Petzl retailer website

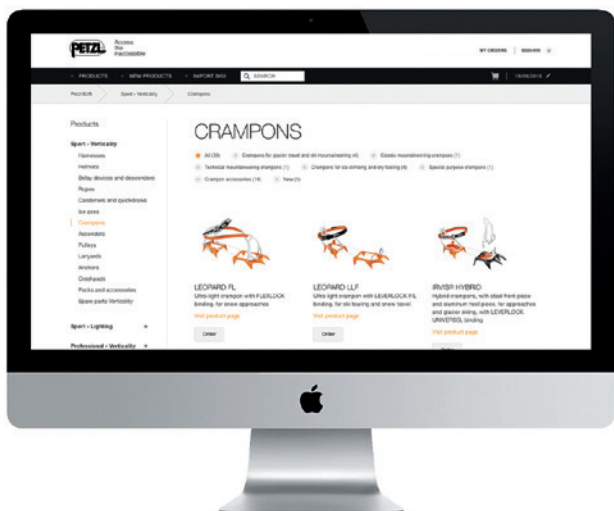

Easy access to all our offerings:

- navigate easily and intuitively
- direct access to our latest products

Manage your products, down to the smallest details:

- comprehensive information on each product
- documents to inform and advise your clients

Order with complete peace of mind:

- three direct access points to order your products
- absolute pricing transparency
- real-time status of Petzl inventories

Track your orders:

- precise status of your current orders
- personalized order tracking

Download information

Quickly find your choice of Petzl information for download.

© PETZL 2020

Product photos
Kalice - www.kalice.fr
Aurélije Jeannette
Yannick Siegel

Printed in Spain by
Comptoir des idées

Access the inaccessible[®]



To find a Petzl retailer near you or
anywhere in the world go to:

www.petzl.com/dealers

↑ Hayden Jamieson and Heather Weidner on *Flight of Fancy*, on Jebel Rum, Jordan.
© 2019 - Petzl Distribution - Jeremiah Watt

↓ Exploring an ice cave under a glacier, Iceland.
© 2019 - Petzl Distribution - Arnaud Childeric

Z019EN03

ENGLISH

